



MATSUI

CASINO EQUIPMENT

CHIP COLOUR CHART

These printed colours are a close representation only and may vary slightly on the finished chip. Please contact your MATSUI sales representative for design and chip colour kit.



Standard Chip Colour



01 Light Blue



02 Aquamarine



03 True Blue



04 Cobalt Blue



05 Ultramarine



06 Dark Blue



07 Indigo Blue



08 Purple



09 Violet



10 Hot Pink



11 Lavender



12 Blush



13 Rose



14 Day-Glo Pink



15 Crimson



16 Maroon



17 Scarlet



18 Vermilion



19 Orange



20 Day-Glo Orange



21 Mandarin Orange



22 Flesh



23 Dandelion Yellow



24 Lemon



25 Mustard



26 Light Green



27 Mint



28 Irish Green



29 Lawn Green



30 Leaf Green



31 Cedar Green



32 Terracotta



33 Dark Brown



34 Sienna Brown



35 Fawn



36 Beige

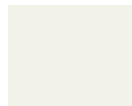

37 Cream

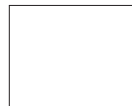

38 White



39 Light Grey



40 Battleship Grey



41 Stone Grey



42 Black



43 Dark Green

Marble Chip Colour



AN04 Sapphire



AN11 Coral



AN13 Magenta



AN14 Canary



AN15 Carmine



AN17 Pearl Gold



AN18 Sand



AN19 Bronze



AN24 Gold



AN25 Pearl Grey



AN29 Syan



AN31 Forest Green

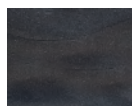

AN32 Antique Black



AN33 Silver

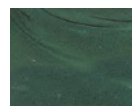

AN41 Emerald

GAMING CHIPS

Utilizing the most recent and accurate technology available, MATSUI has now extended their existing range of highly durable gaming chips. In addition to their hard wearing properties, all Matsui gaming chips feel great to the touch and are perfectly weighted for any casino player.



INNER RING STYLE
DECAL VALUE CHIPS



DECAL VALUE
CHIPS

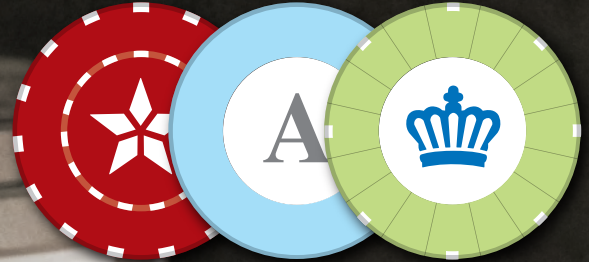

ROULETTE WHEELCHECKS



COIN INLAY VALUE CHIPS



GOLD / SILVER CHIPS



PAD PRINT / HOT STAMP
CHIPS



PREMIER DECAL CHIPS



PREMIER DECAL CHIPS
OVAL



ACRYLIC PLAQUES

CHIP COLOUR COMBINATION



SECURITY OPTION

- Visible UV
- Invisible UV
- Mould UV
- MG EYE Security Printing
- MG EYE Edge
- Laser Trace
- EM Tag
- RFID

ADDITIONAL DESIGNS

- Glitter
- Mirror Silver
- Mirror Gold
- Serial Numbers
- Hologram

INNER RING STYLE

Decal Value Chips

Matsui Inner Ring Decal Chips are our most popular and best-selling casino chips. We have a wide selection with a full range of denominations. The inner rings moulds are available in number only, \$ and € and will fit 39mm, 40mm and 43mm chips. With this wide-ranging selection, we are sure to have the denominations you require and it is also possible to customize your own unique inner ring mould.



40 mm 2 colour

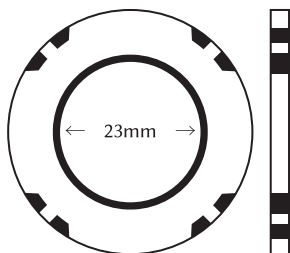

CC.610-A ϕ 39/40

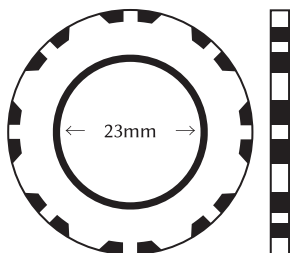

CC.610-B ϕ 39/40

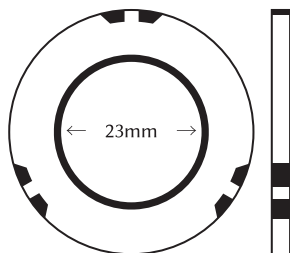

CC.610-C ϕ 39/40

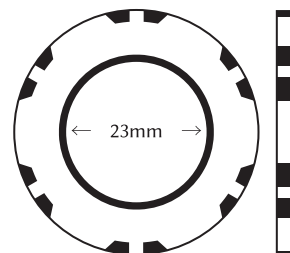

CC.610-D ϕ 39/40

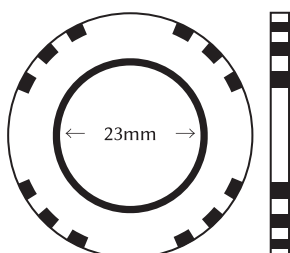

CC.310-K ϕ 39/40

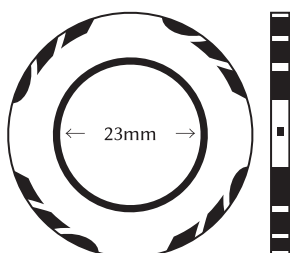

CC.710-A ϕ 40

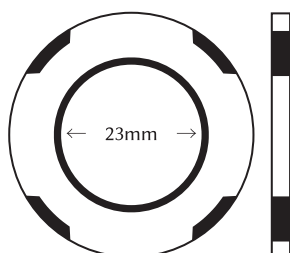

CC.620-E ϕ 39/40

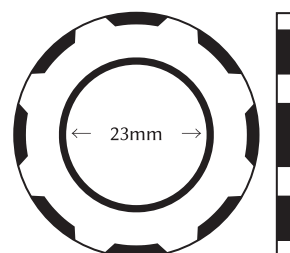

CC.620-F ϕ 39/40

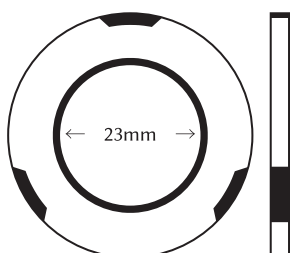

CC.620-G ϕ 39/40

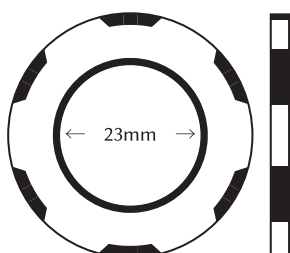

CC.620-H ϕ 39/40

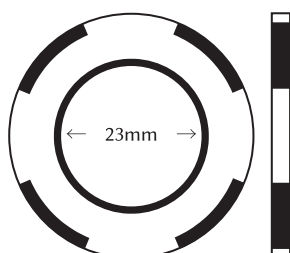

CC.320-E ϕ 39/40

40 mm 3 colour

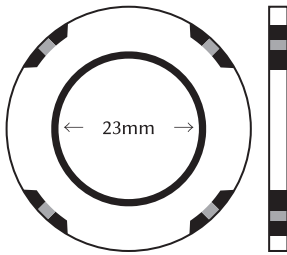

CC.620-A ϕ 39/40

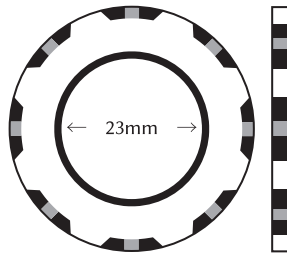

CC.620-B ϕ 39/40

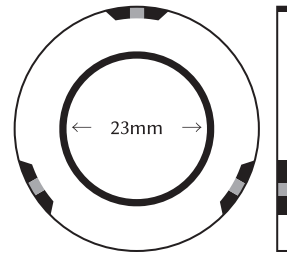

CC.620-C ϕ 39/40

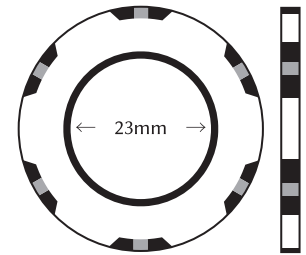

CC.620-D ϕ 39/40

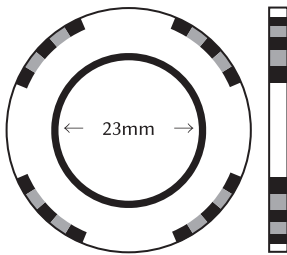

CC.320-D ϕ 39/40

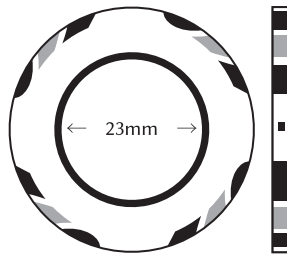

CC.720-A ϕ 40

40 mm 4 colour

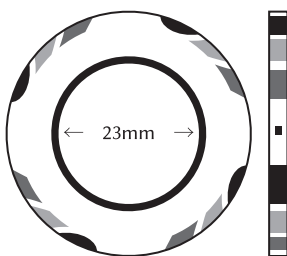

CC.730-A ϕ 40

CHIP COLOUR COMBINATION

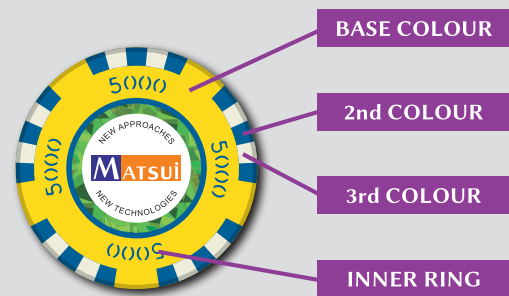

*Inner Ring to be same colour as 2nd colour

SECURITY OPTION

- Visible UV
- Invisible UV
- Mould UV
- MG EYE Security Printing
- MG EYE Edge
- Laser Trace
- EM Tag
- RFID

ADDITIONAL DESIGNS

- Glitter
- Mirror Silver
- Mirror Gold
- Serial Numbers
- Hologram

43 mm 2 colour

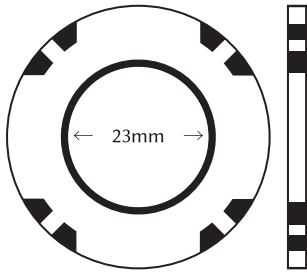

CC.630-A ϕ 43

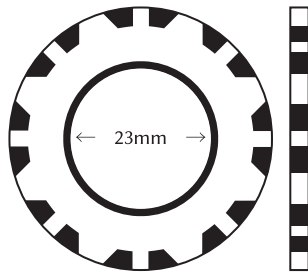

CC.630-B ϕ 43

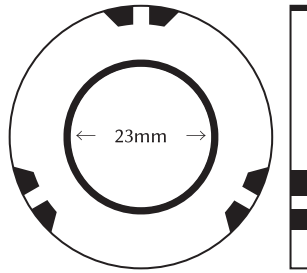

CC.630-C ϕ 43

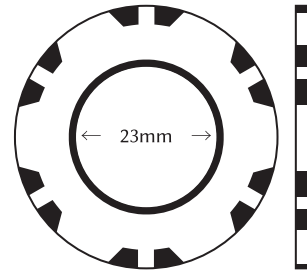

CC.630-D ϕ 43

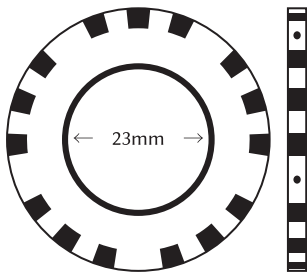

CC.630-I ϕ 43

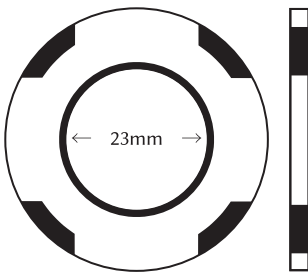

CC.640-E ϕ 43

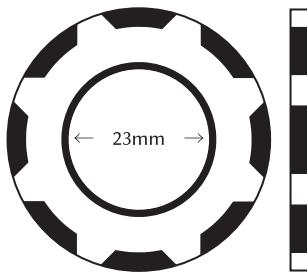

CC.640-F ϕ 43

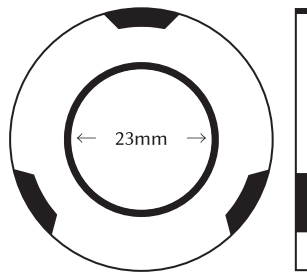

CC.640-G ϕ 43

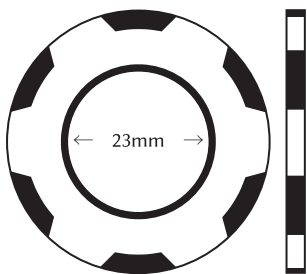

CC.640-H ϕ 43

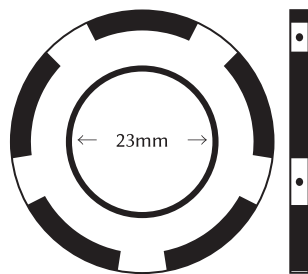

CC.640-J ϕ 43

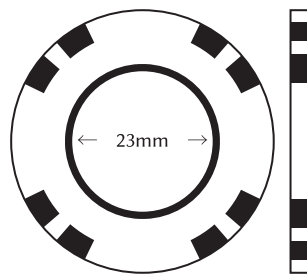

CC.330-C ϕ 43

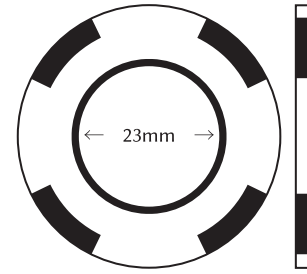

CC.340-D ϕ 43

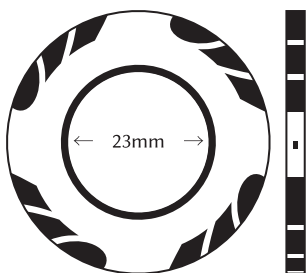

CC.810-A ϕ 43

CHIP COLOUR COMBINATION

- BASE COLOUR
- 2nd COLOUR
- INNER RING

*Inner Ring to be same colour as 2nd colour

43 mm 3 colour

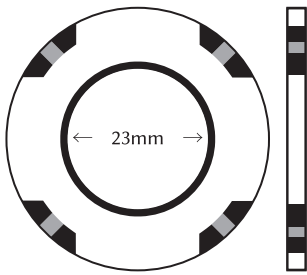

CC.640-A ϕ 43

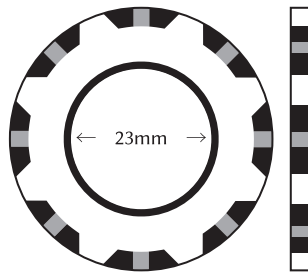

CC.640-B ϕ 43

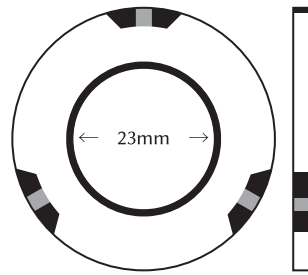

CC.640-C ϕ 43

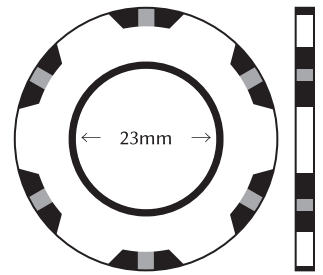

CC.640-D ϕ 43

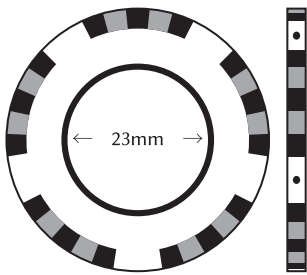

CC.640-I ϕ 43

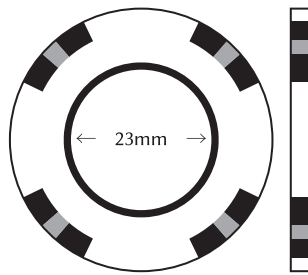

CC.340-C ϕ 43

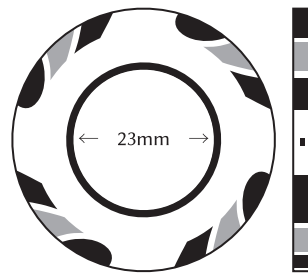

CC.820-A ϕ 43

43 mm 4 colour

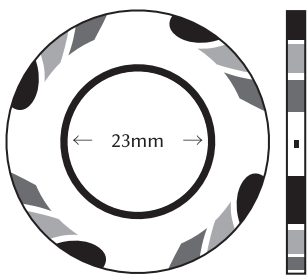

CC.830-A ϕ 43

45 mm 2 colour

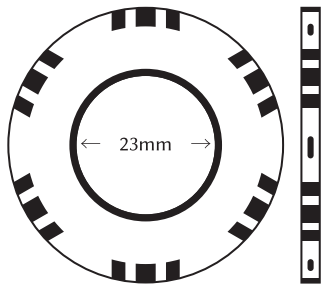

CC.635-A ϕ 45

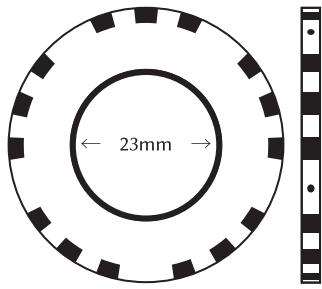

CC.635-C ϕ 45

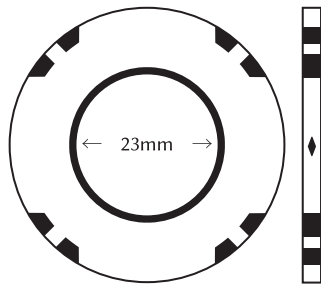

CC.635-E ϕ 45

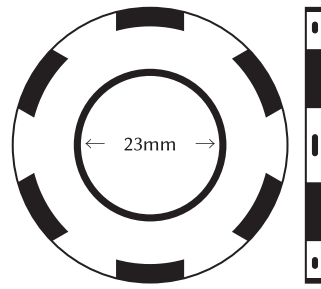

CC.645-B ϕ 45

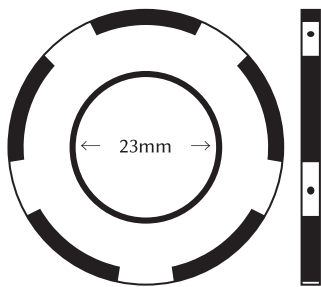

CC.645-D ϕ 45

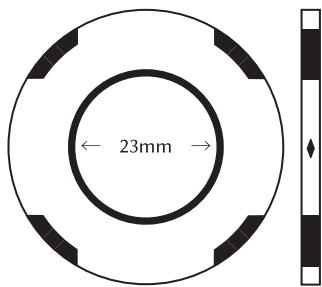

CC.645-F ϕ 45

45 mm 3 colour

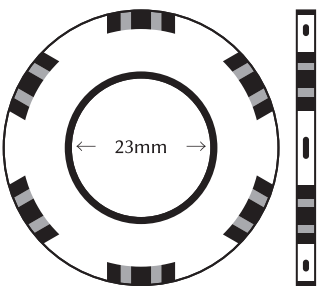

CC.645-A ϕ 45

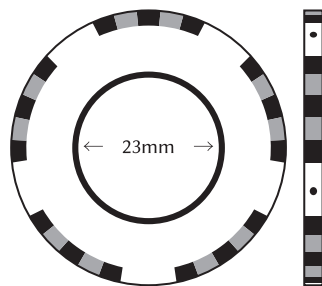

CC.645-C ϕ 45

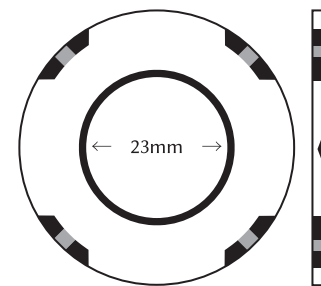

CC.645-E ϕ 45

50 mm 2 colour

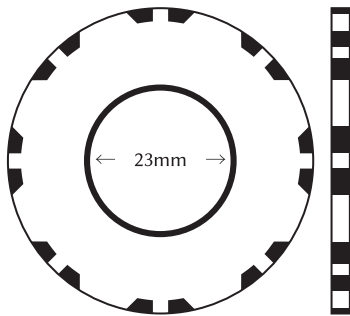

CC.650-A ϕ 50

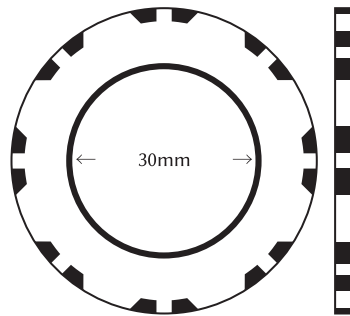

CC.650-B ϕ 50

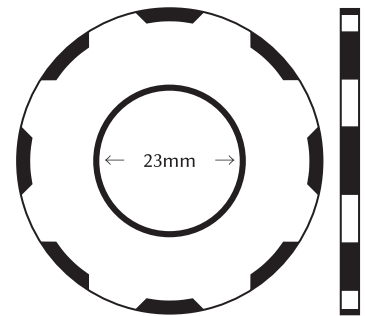

CC.660-C ϕ 50

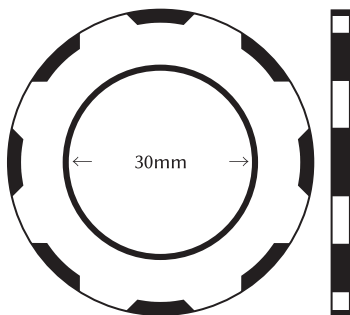

CC.660-D ϕ 50

50 mm 3 colour

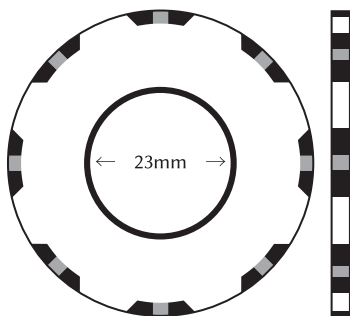

CC.660-A ϕ 50

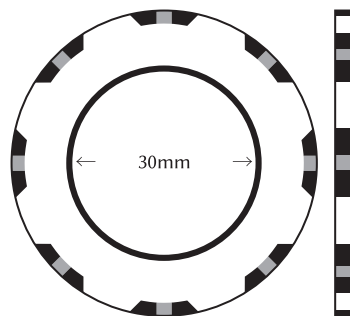

CC.660-B ϕ 50

One colour Inner Series

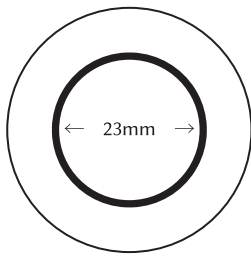

CC.610-S ϕ 39/40

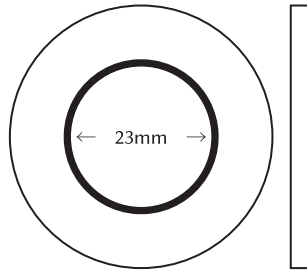

CC.630-S ϕ 43

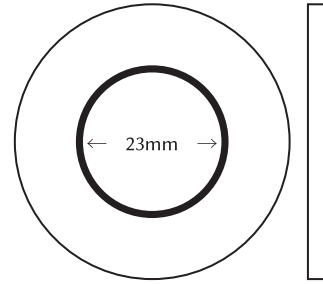

CC.635-S ϕ 45

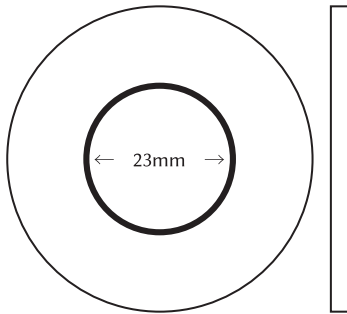

CC.650-S ϕ 50

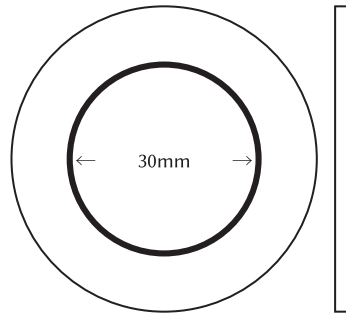

CC.655-S ϕ 50



INNER RING Designs

We have many inner ring designs and denominations available as standard. There is also the further option to have your own casino name in the inner ring of the chip for a more personalized appearance.



Inner Ring Designs 40/43/45 mm

Decal 23mm ONLY

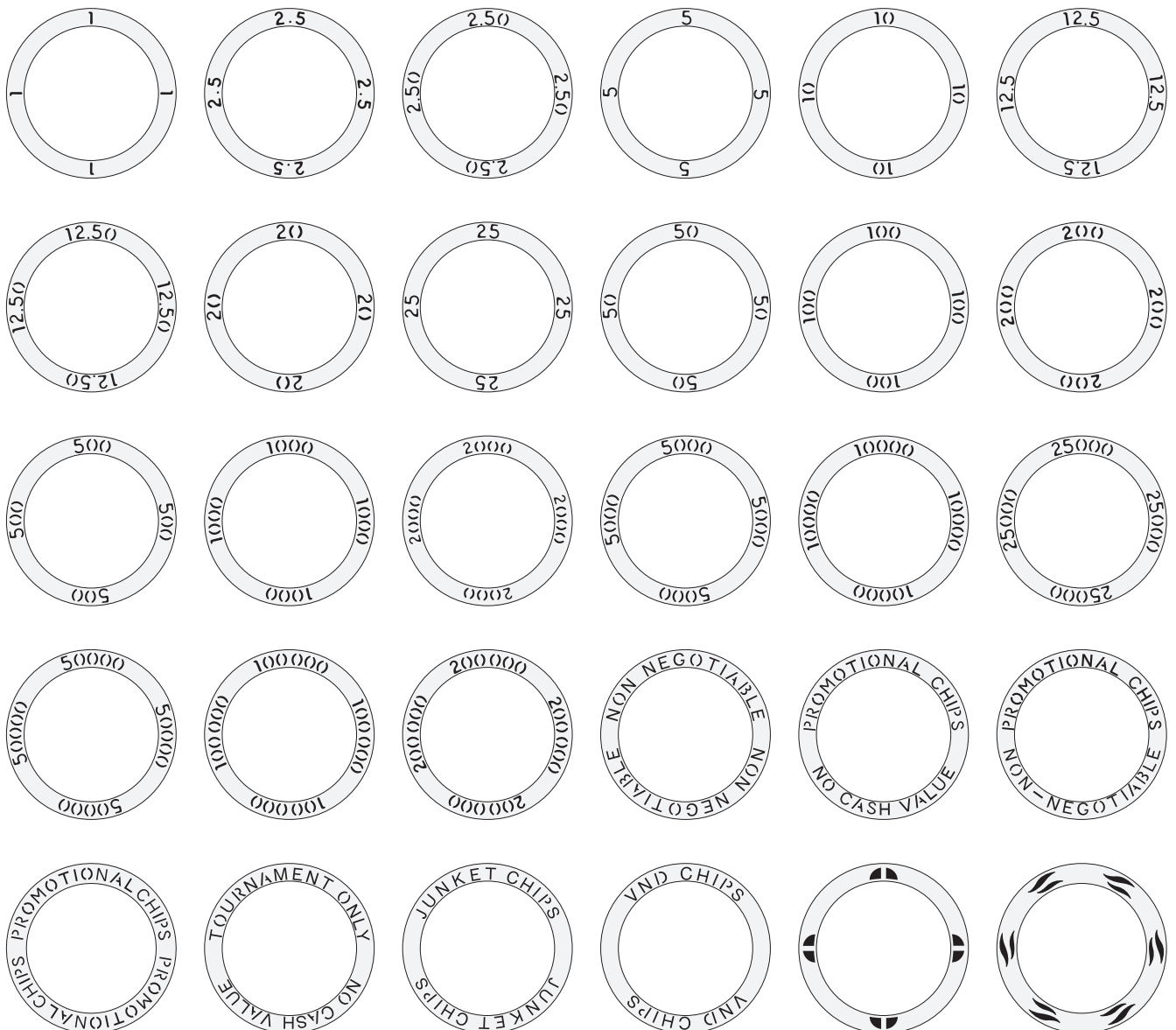

INNER RING CAN BE CUSTOMIZED

Other inner ring designs are also available. Please contact your local sales representative for more information.

*The ability to customize chips with your casino name is available.

*The inner ring color is always the same as the second colour of your chip.



EP Inner Ring Designs 40/43/45 mm

Decal 23mm ONLY

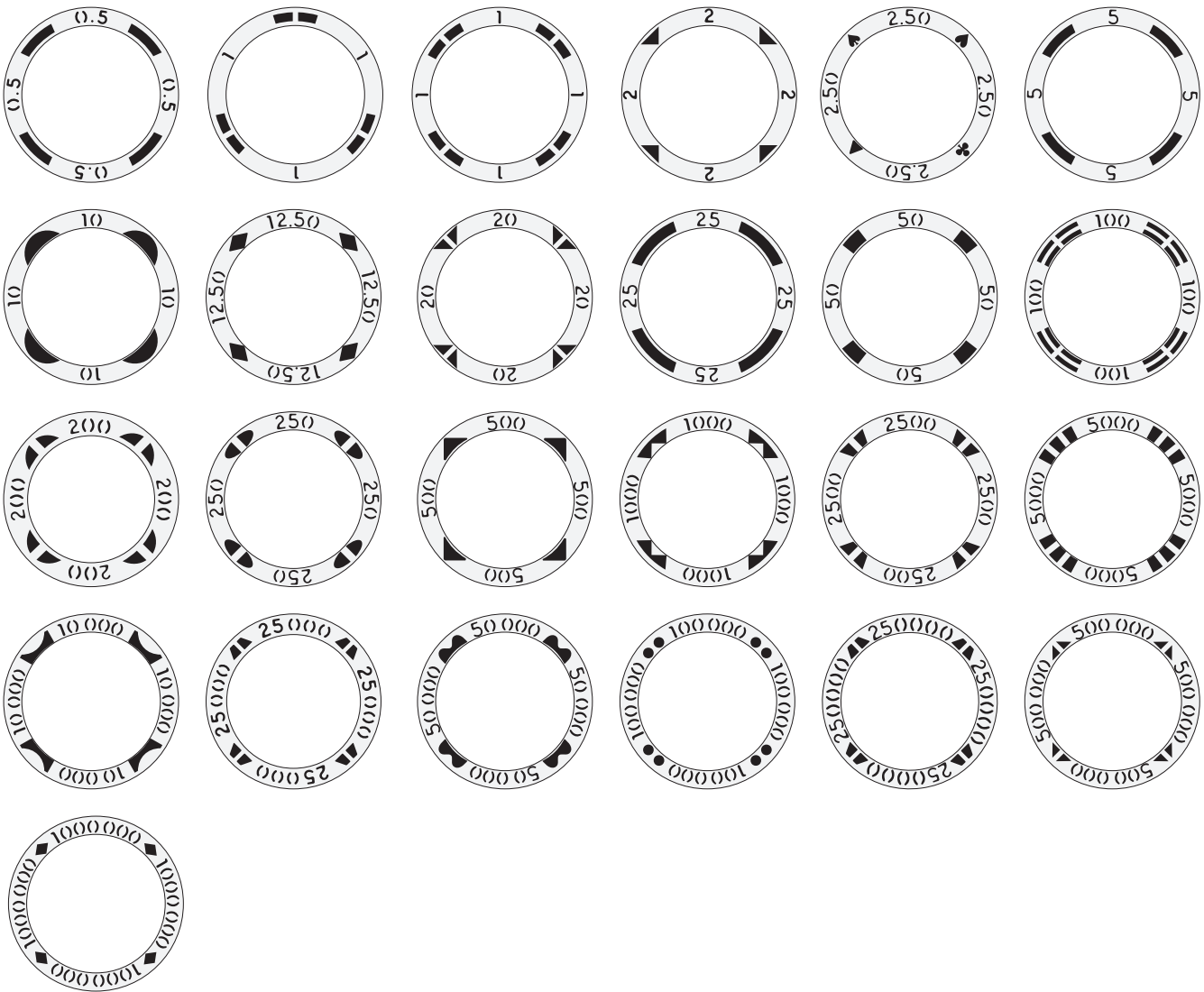

\$ Inner Ring Designs 40/43/45 mm

Decal 23mm ONLY

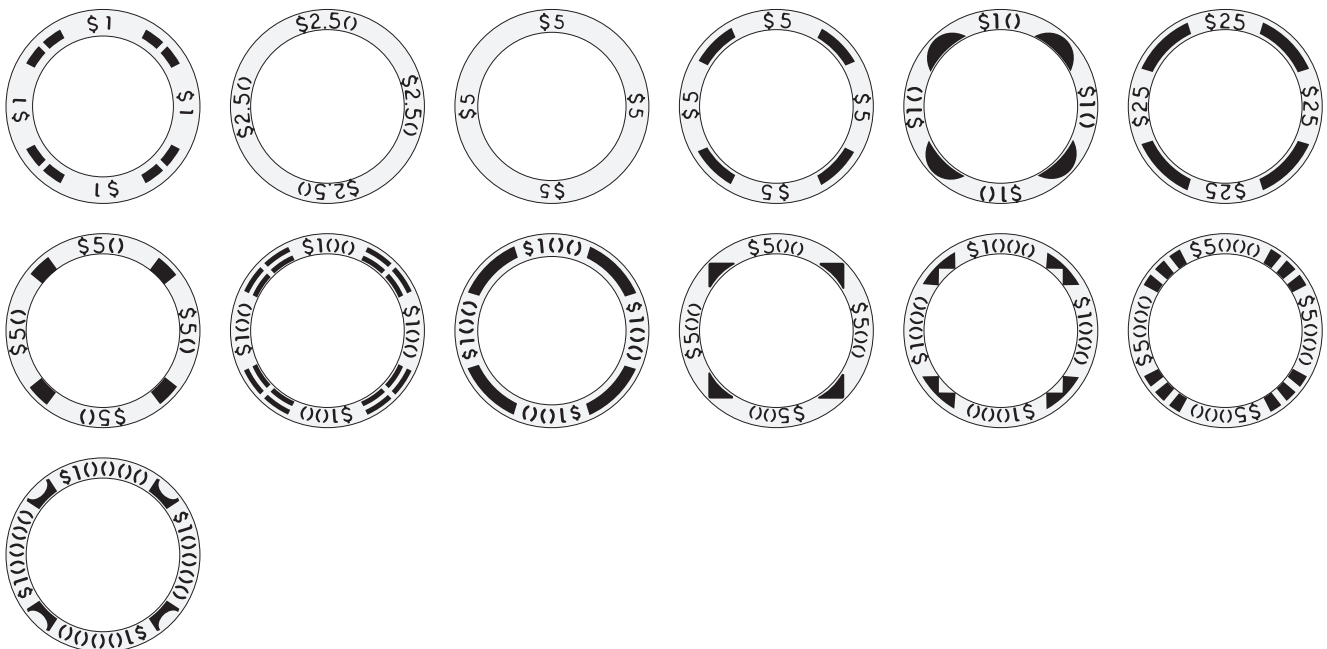

€ Inner Ring Designs 40/43/45 mm

Decal 23mm ONLY

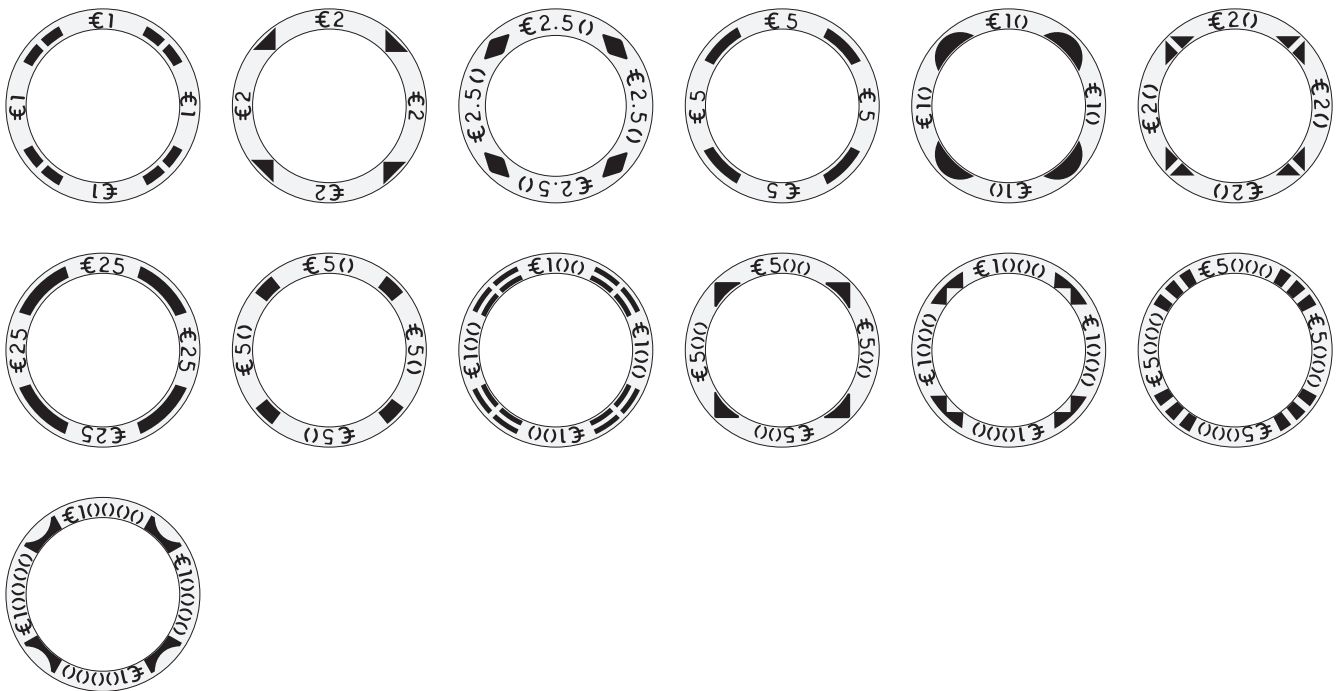

Inner Ring Designs 50 mm

Decal 23mm CC650-A, CC660-A, CC660-C ONLY



Inner Ring Designs 50 mm

Decal 30mm CC650-B, CC660-B, CC660-D ONLY

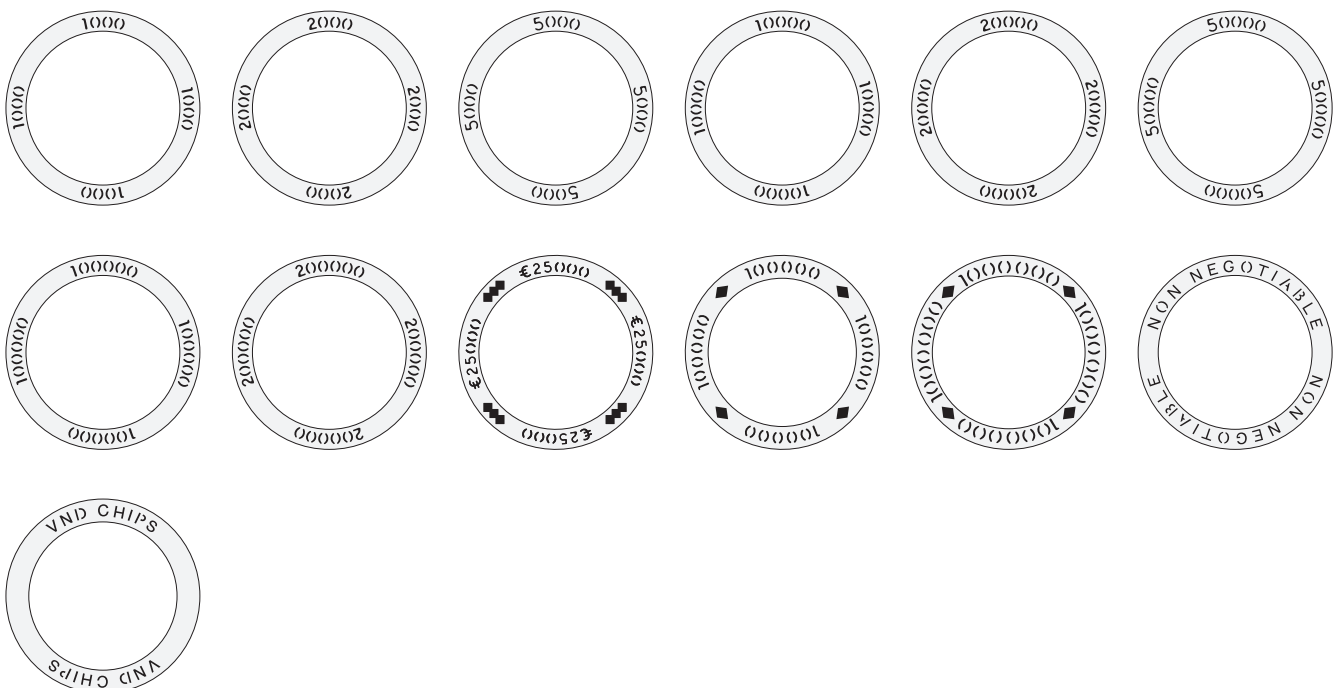

HEAVY WEIGHT INNER RING STYLE

Decal Value Chips

40 mm 2 colour

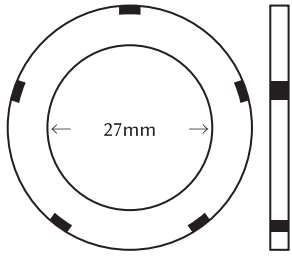

CC.910-A ϕ 40

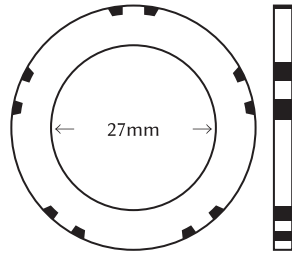

CC.910-B ϕ 40

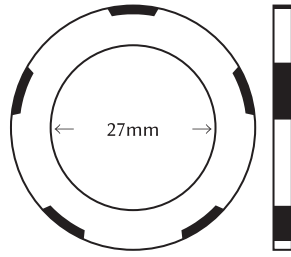

CC.910-C ϕ 40

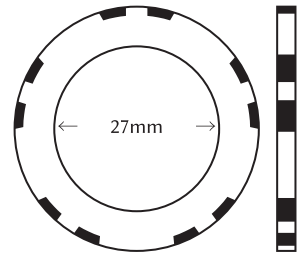

CC.910-D ϕ 40

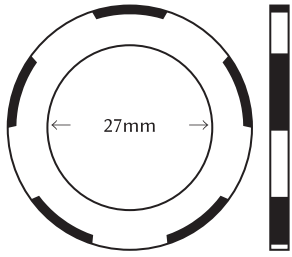

CC.910-E ϕ 40

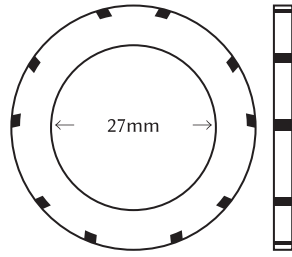

CC.910-F ϕ 40

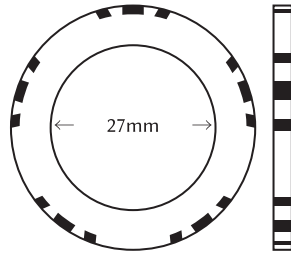

CC.910-G ϕ 40

40 mm 3 colour

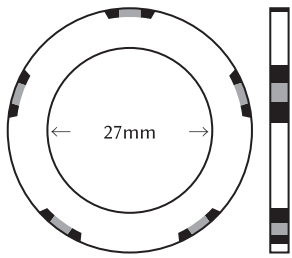

CC.920-A ϕ 40

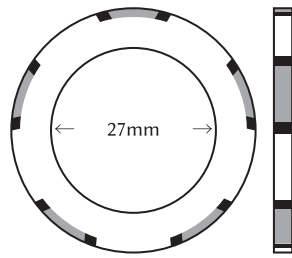

CC.920-B ϕ 40

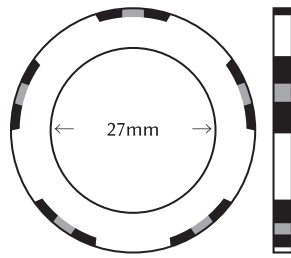

CC.920-C ϕ 40

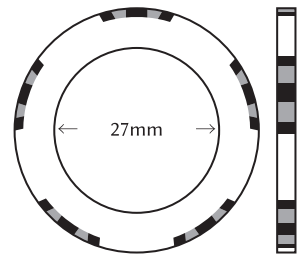

CC.920-D ϕ 40

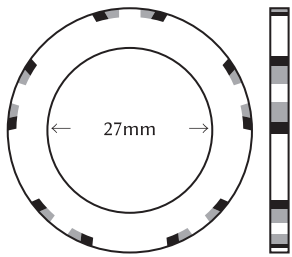

CC.920-E ϕ 40

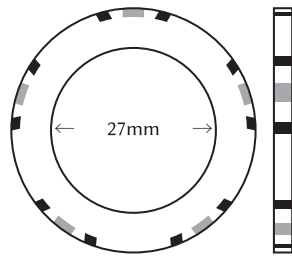

CC.920-F ϕ 40

40 mm 4 colour

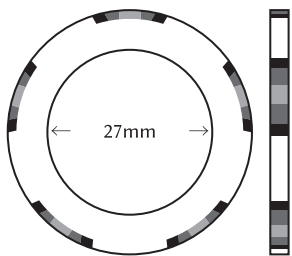

CC.950-A ϕ 40

43 mm 2 colour

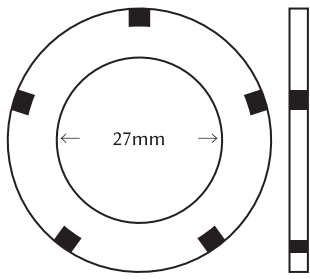

CC.930-A φ43

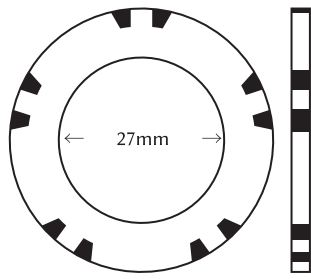

CC.930-B φ43

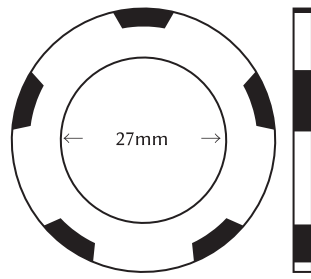

CC.930-C φ43

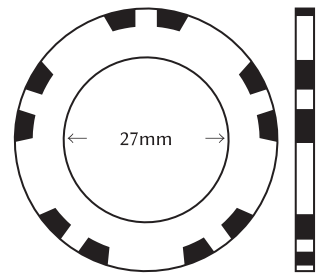

CC.930-D φ43

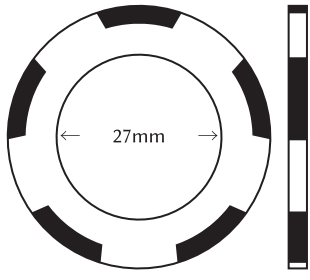

CC.930-E φ43

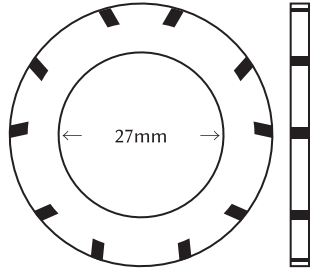

CC.930-F φ43

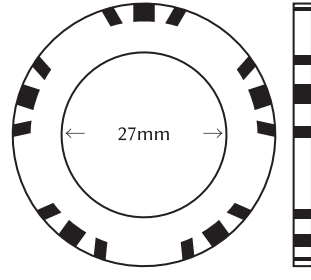

CC.930-G φ43

43 mm 3 colour

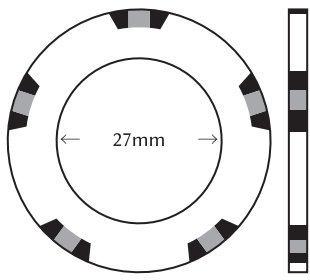

CC.940-A φ43

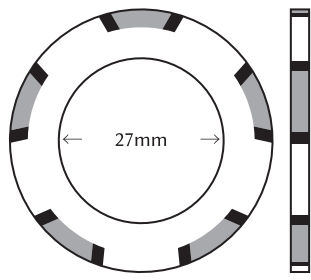

CC.940-B φ43

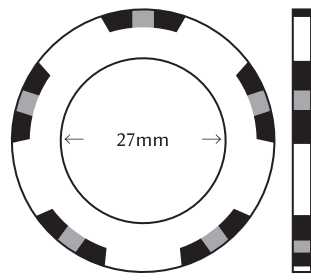

CC.940-C φ43

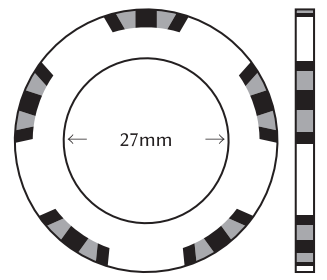

CC.940-D φ43

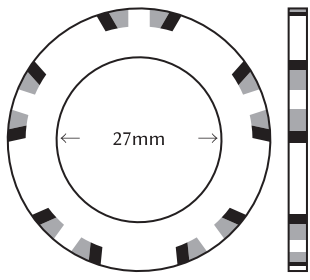

CC.940-E φ43

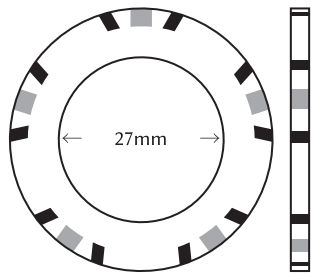

CC.940-F φ43

43 mm 4 colour

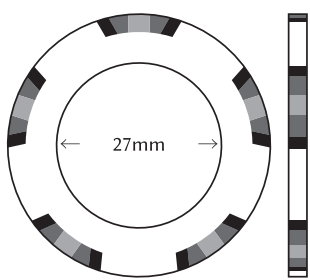

CC.960-A φ43

45 mm 2 colour

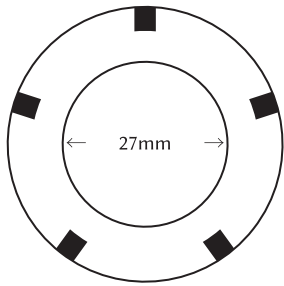

CC.935-A ϕ 45

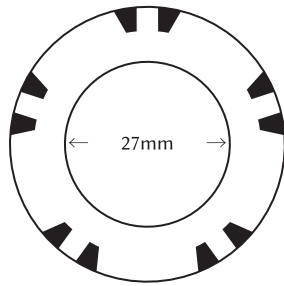

CC.935-B ϕ 45

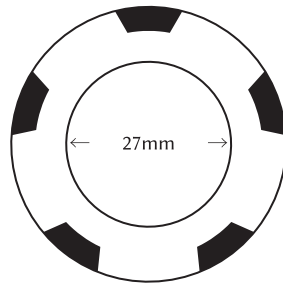

CC.935-C ϕ 45

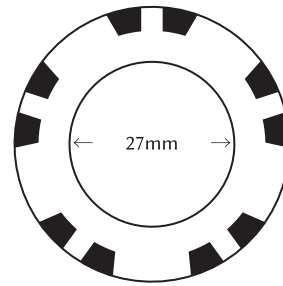

CC.935-D ϕ 45

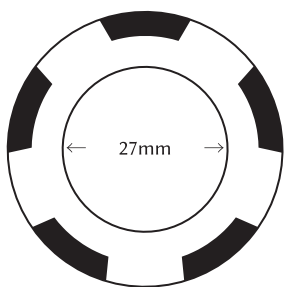

CC.935-E ϕ 45

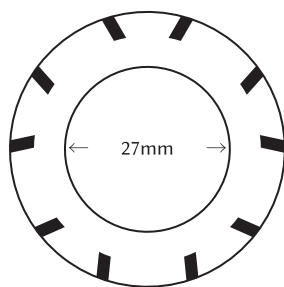

CC.935-F ϕ 45

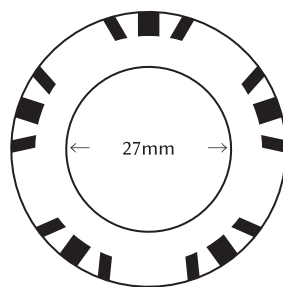

CC.935-G ϕ 45

45 mm 3 colour

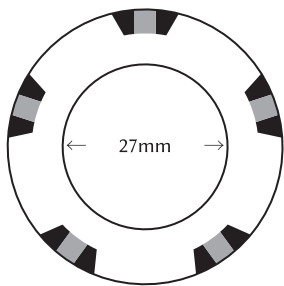

CC.945-A ϕ 45

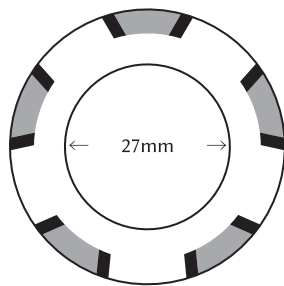

CC.945-B ϕ 45

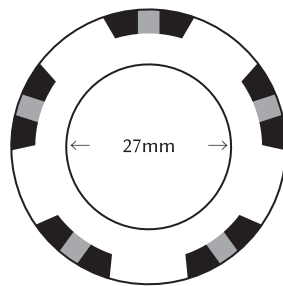

CC.945-C ϕ 45

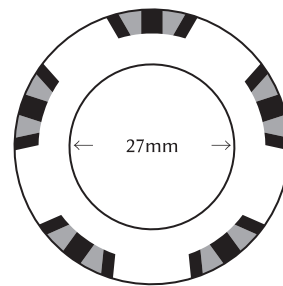

CC.945-D ϕ 45

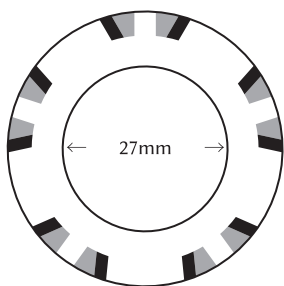

CC.945-E ϕ 45

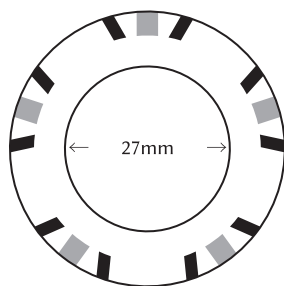

CC.945-F ϕ 45

45 mm 4 colour

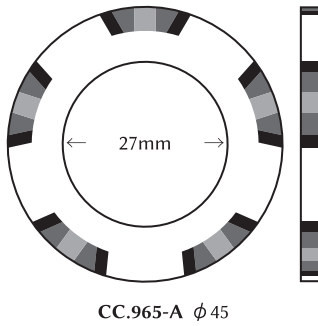

HEAVY WEIGHT INNER RING STYLE INNER RING

Inner Ring Designs 40/43/45 mm Decal 27mm ONLY

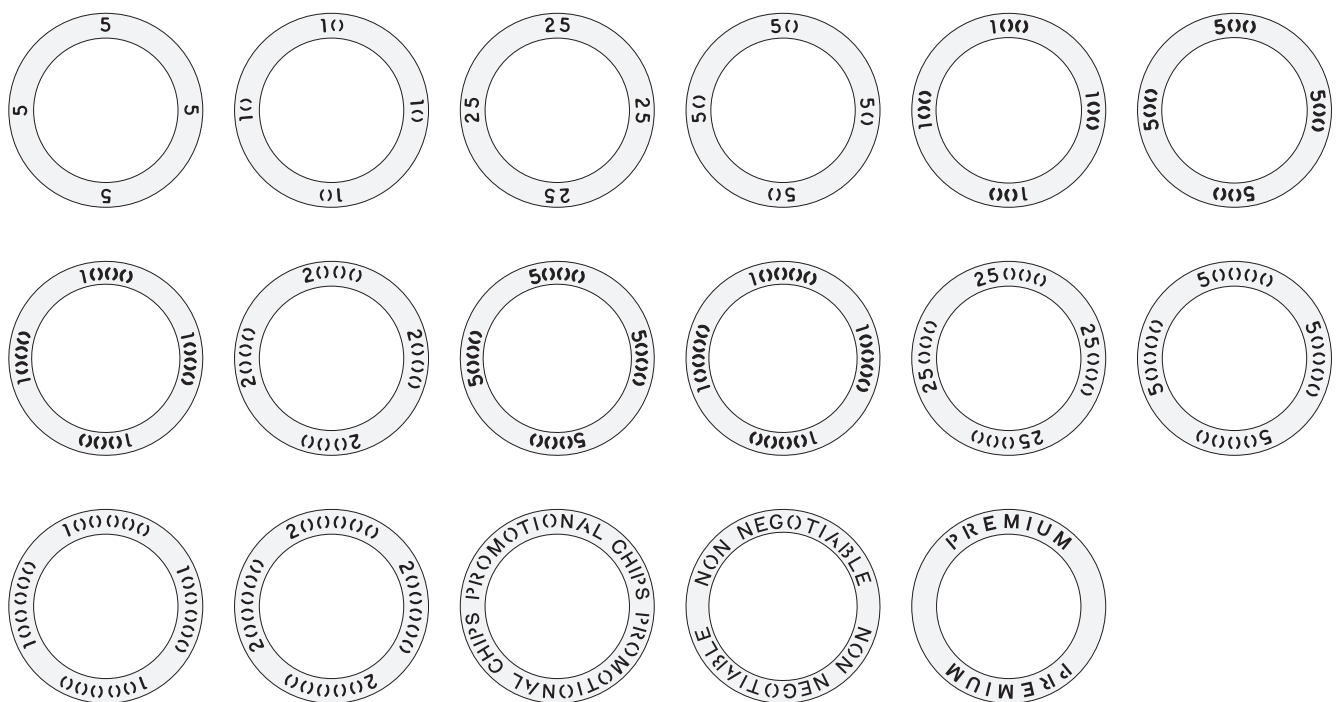

DECAL VALUE Chips

With Matsui chips going through numerous precision moulding techniques and quality control procedures, our chips feel perfect in weight and texture. With 50+ different colors to choose from, there's sure to be a colour combination to suit your taste and security requirements.



40 mm 2 colour

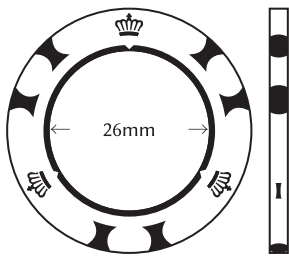

CC.310-A ϕ 40

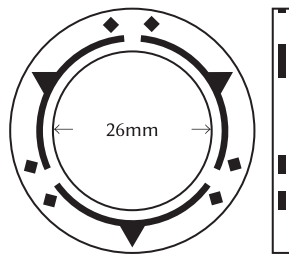

CC.310-B ϕ 40

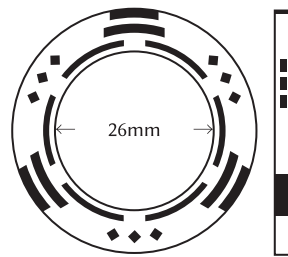

CC.310-C ϕ 40

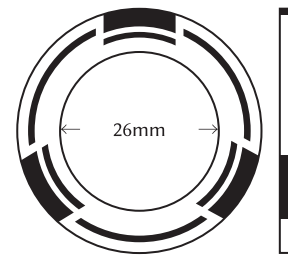

CC.310-D ϕ 39/40

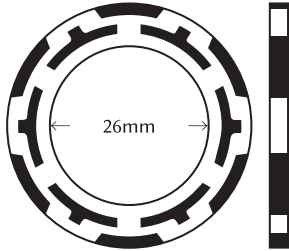

CC.310-E ϕ 39/40

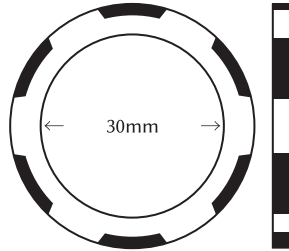

CC.310-F ϕ 39/40

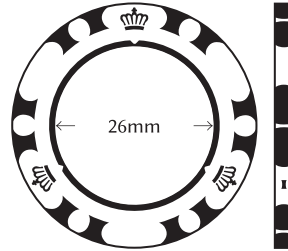

CC.310-G ϕ 40

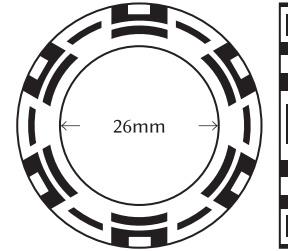

CC.310-H ϕ 39/40

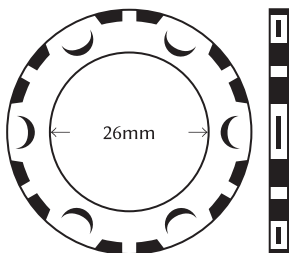

CC.310-I ϕ 39/40

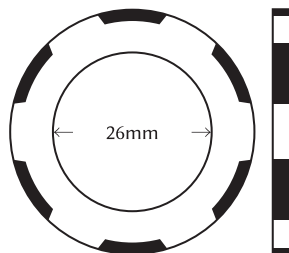

CC.310-J ϕ 39/40

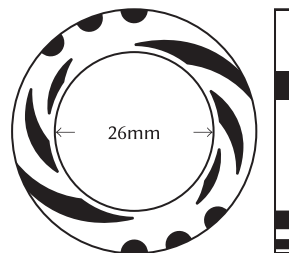

CC.310-L ϕ 39/40

Front and back designs are not symmetrical

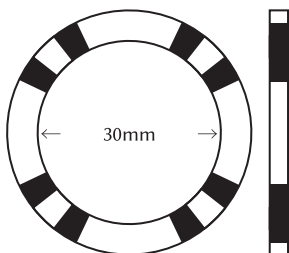
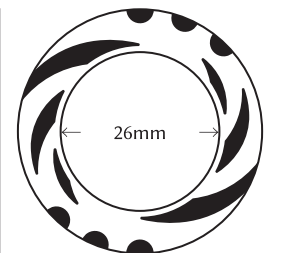

CC.350-A ϕ 39/40
Normal

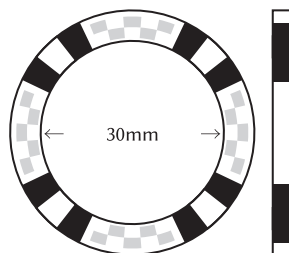

CC.350-B ϕ 39/40
With Indentation

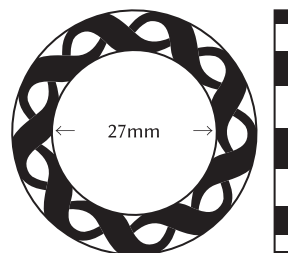

CC.710-B ϕ 39.70/40

40 mm 3 colour

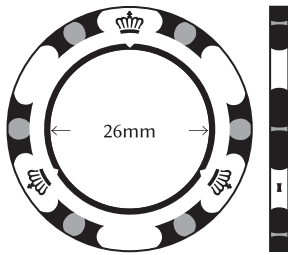
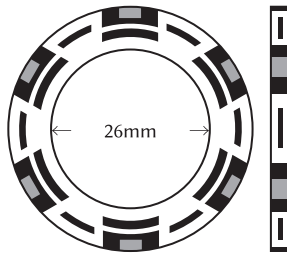
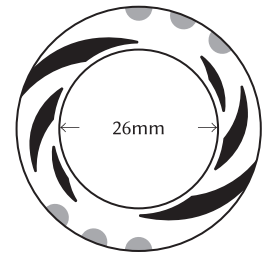
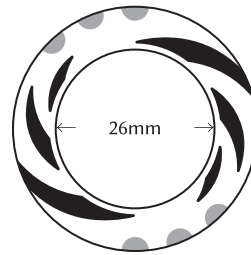
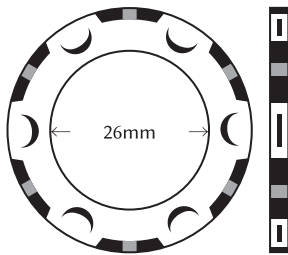
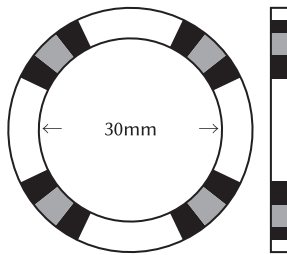
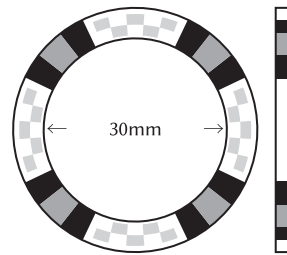
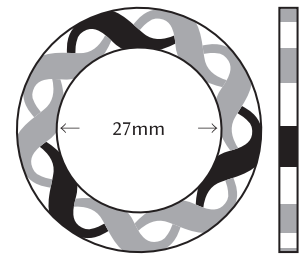
CC.320-A ϕ 40CC.320-B ϕ 39/40CC.320-F ϕ 39/40
Front and back designs are not symmetricalCC.320-C ϕ 39/40CC.360-A ϕ 39/40
NormalCC.360-B ϕ 39/40
With IndentationCC.720-B ϕ 39.70/40

40 mm 4 colour

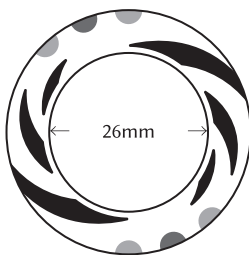
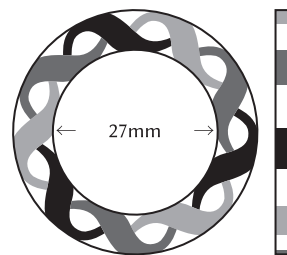
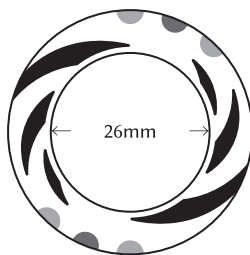
CC.325-F ϕ 39/40
Front and back designs are not symmetricalCC.730-B ϕ 39.70/40

40 mm 1 colour

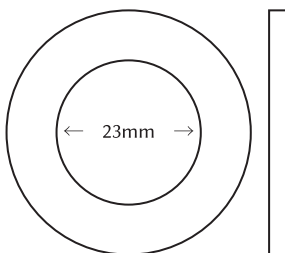
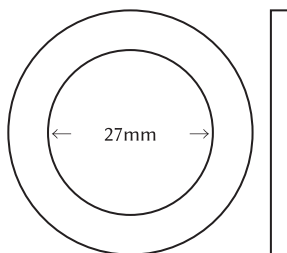
CC.170 ϕ 39/40
No inner ring availableCC.910-S ϕ 39/40
No inner ring available

43 mm 2 colour

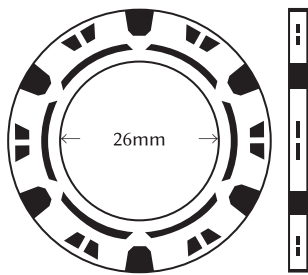

CC.330-A ϕ 43

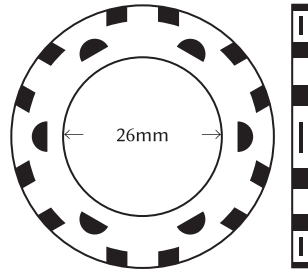

CC.330-B ϕ 43

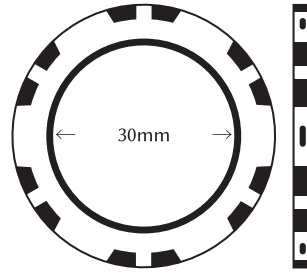

CC.330-F ϕ 43

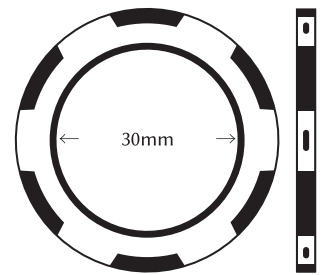

CC.340-G ϕ 43

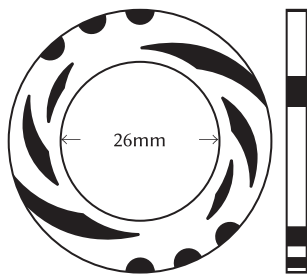

CC.331-F ϕ 43

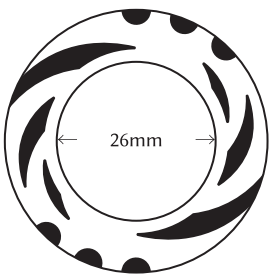

43 mm 3 colour

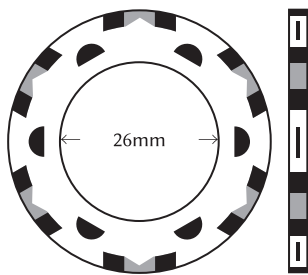

CC.340-A ϕ 43

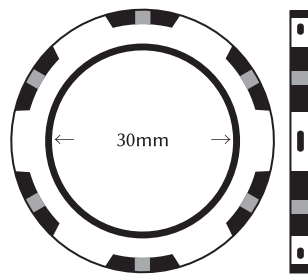

CC.340-F ϕ 43

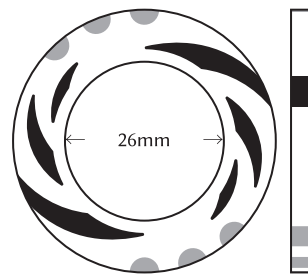

CC.341-F ϕ 43

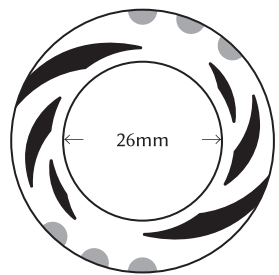

43 mm 1 colour

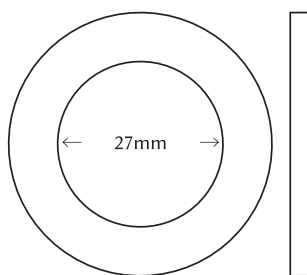

CC.930-S ϕ 43
No inner ring available

45 mm 2 colour

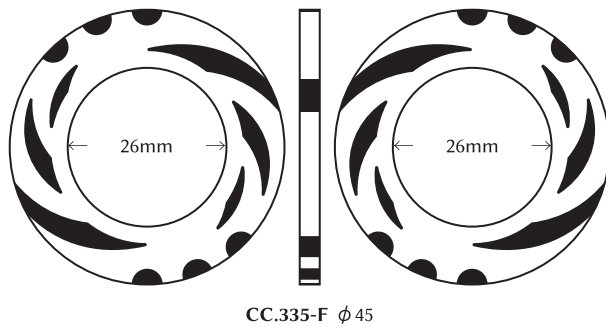

45 mm 3 colour

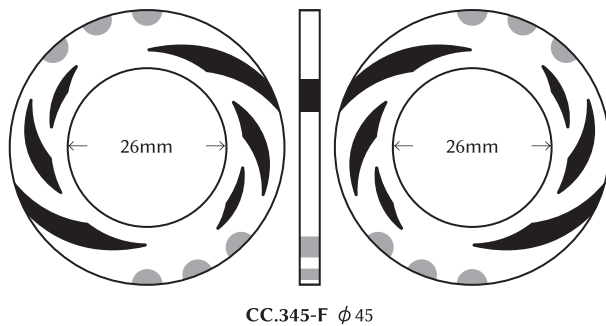

45 mm 1 colour

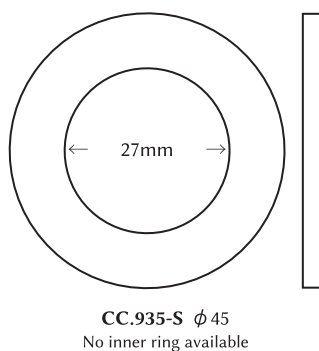

CHIP COLOUR COMBINATION

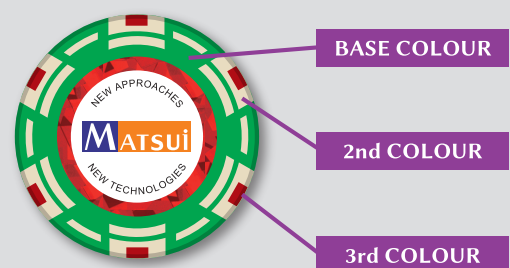

ADDITIONAL DESIGNS

- Glitter • Mirror Silver or Gold • Serial Numbers
- Hologram

SECURITY OPTION

- Visible UV • Invisible UV • MG EYE Security Printing
- MG EYE Edge • Laser Trace • Mould UV • EM Tag
- RFID

CIRCULAR EDGE DECAL 40 mm 2 colour

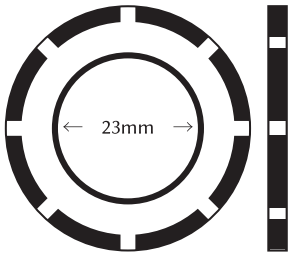

CC.611-D ϕ 39/40

CIRCULAR EDGE DECAL 40 mm 3 colour

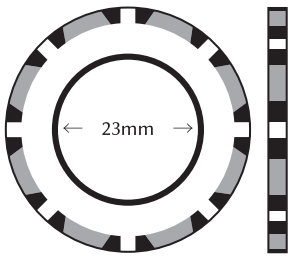

CC.621-D ϕ 39/40

CIRCULAR EDGE DECAL 43 mm 2 colour

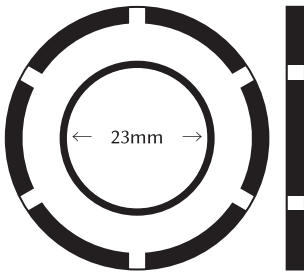

CC.631-C ϕ 43

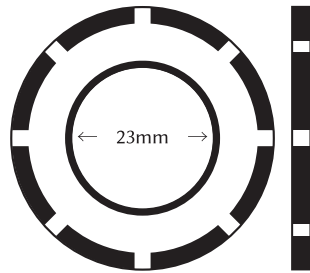

CC.631-D ϕ 43

CIRCULAR EDGE DECAL 43 mm 3 colour

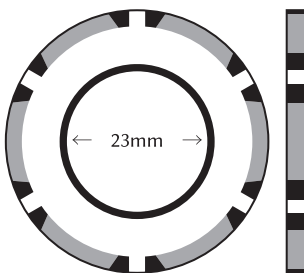

CC.641-C ϕ 43

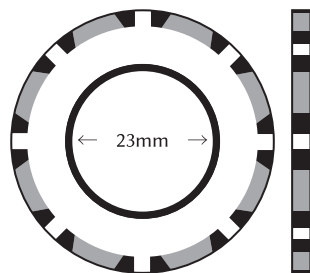

CC.641-D ϕ 43

HOTSTAMP & PAD Printing Chips

Ideal for poker chips or low end value chips, the centre hotstamp design can be customized to your requirements.
The hotstamp and PAD printing is also available in various colours.



1 colour Hotstamp and Pad Printing Chip

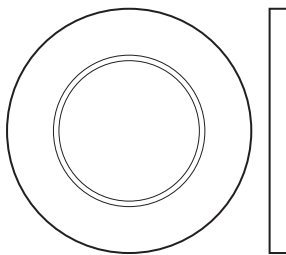

CC.110 ϕ 39/40

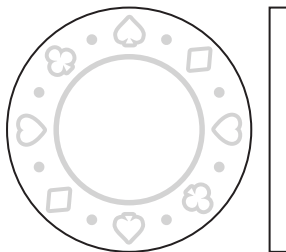

CC.100 ϕ 39/40



2 colour Hotstamp and Pad Printing Chip

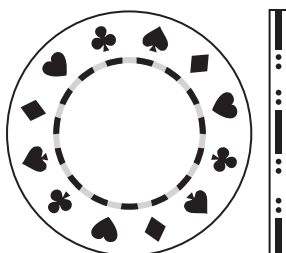

CC.140 ϕ 39/40



WHEELCHECKS

High quality and extremely durable
MATSUI wheelchecks.
Please contact a sales representative
to discuss your design ideas.



Decal Wheelchecks

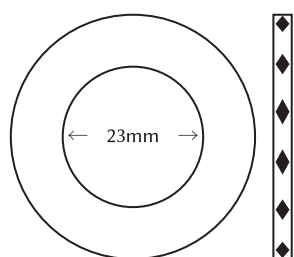

CC.120 ϕ 39/40

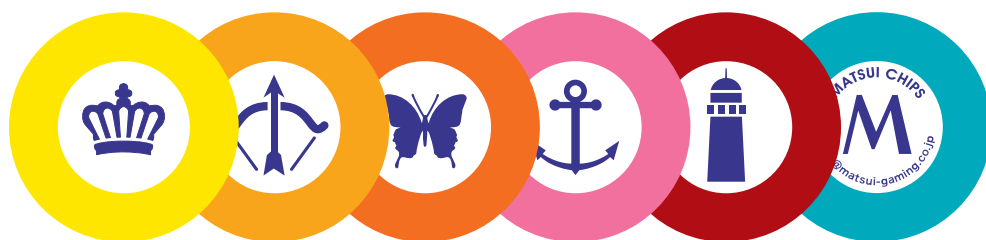

Crown Archery Butterfly Anchor Tower Etc

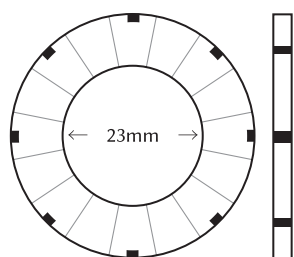

CC.150 ϕ 39/40

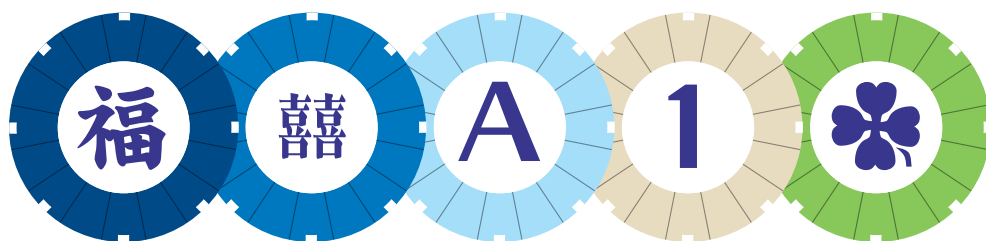

Luck Happiness Alphabetical Numerical Clover

Moulded Wheelchecks

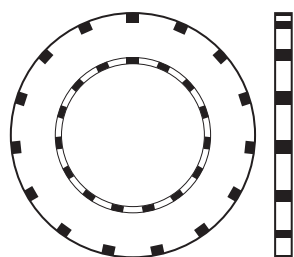

CC.130 ϕ 39/40

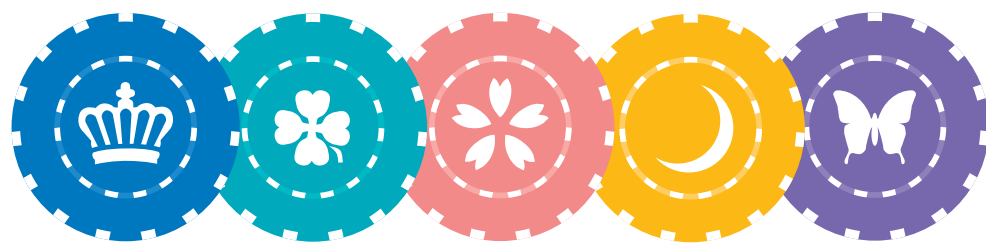

Crown Clover Cherry Moon Butterfly



Bell Tower Star Archery Anchor

CC120/CC150 Standard Decal Design



Anchor



Archery



Bell

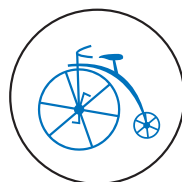

Bicycle



Bird



Buck



Butterfly



Car



Cherry



Clover



Crown

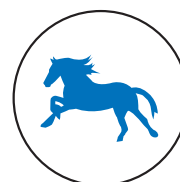

Horse



Moon



Plane



Sailboat

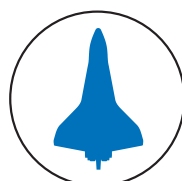

Shuttle

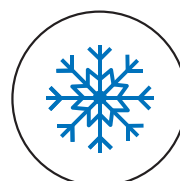

Snowflake1



Snowflake2



Star



Sun



Tower



Windmill



Double Happiness



Good Fortune



Wealth



Long Life



Lucky



Lucky



Plenty



Prosperity



A

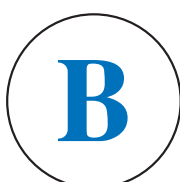

B

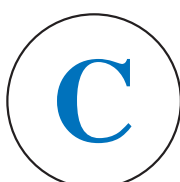

C



D



E



F



G



H



I



J

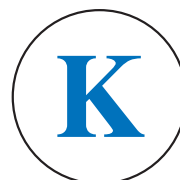

K

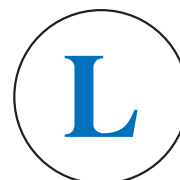

L

COIN INLAY Value Chips & GOLD / SILVER Chips

MATSUI coin inlay chips and heavy-weight Gold / Silver Chips are highly polished and the centre part can be engraved to meet your design specifications. These chips are also available in assorted colour combinations.



Coin Inlay Value Chips

40 mm 2 colour

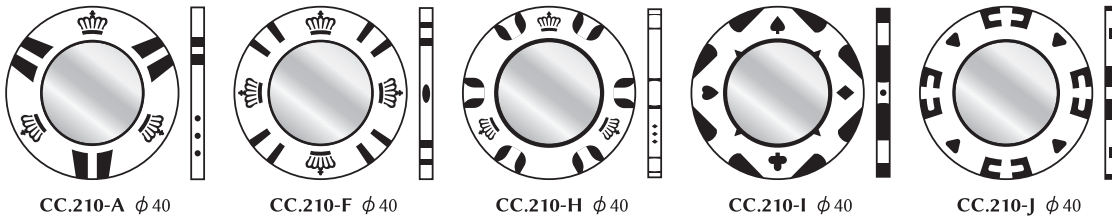

CC.210-A ϕ 40

CC.210-F ϕ 40

CC.210-H ϕ 40

CC.210-I ϕ 40

CC.210-J ϕ 40

40 mm 3 colour

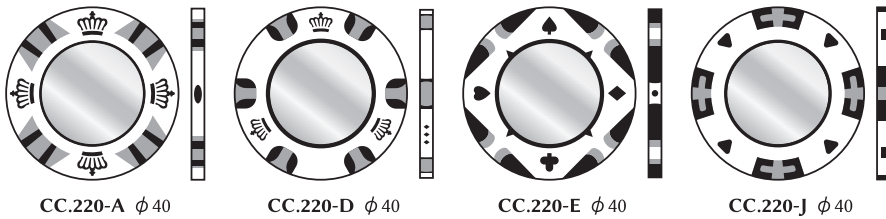

CC.220-A ϕ 40

CC.220-D ϕ 40

CC.220-E ϕ 40

CC.220-J ϕ 40



Silver Colour

Gold Colour

Coin Colours

Available in two different coin colours.

Gold / Silver Chips

40 mm 2 colour

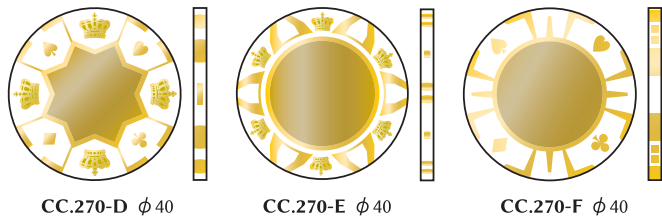

CC.270-D ϕ 40

CC.270-E ϕ 40

CC.270-F ϕ 40

40 mm 3 colour

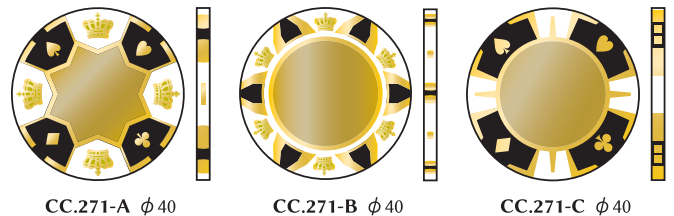

CC.271-A ϕ 40

CC.271-B ϕ 40

CC.271-C ϕ 40

43 mm 2 colour

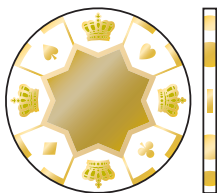

CC.290-A ϕ 43

43 mm 3 colour



CC.291-A ϕ 43



Silver Colour

Gold Colour

Base Colours

Available in two different base colours.

ACRYLIC PLAQUES & JETON

Adding to our already established range of high quality gaming chips, the MATSUI group are now pleased to offer Plaques & Jetons to the casino market. Available in virtually all shapes and sizes with reassurance of different security features.



Rectangle



Rectangle (corner cut)



Oval



Jeton



Size We can cut PLAQUES and JETONS to any size or shape from our extensive range.

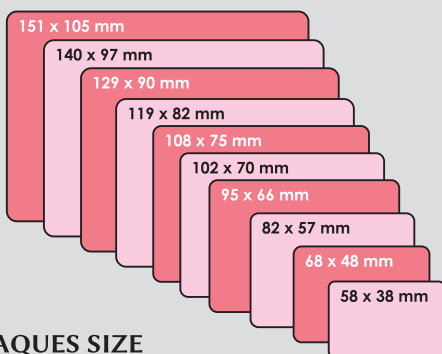

PLAQUES SIZE

58mm x 38mm to 151mm x 105mm
(2.32 inch x 1.52 inch to 6.04 inch x 4.2 inch)

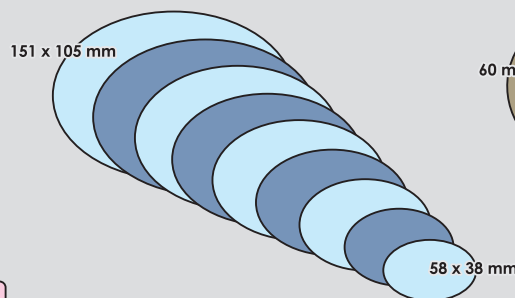

OVAL SIZE

58mm x 38mm to 151mm x 105mm
(2.32 inch x 1.52 inch to 6.04 inch x 4.2 inch)

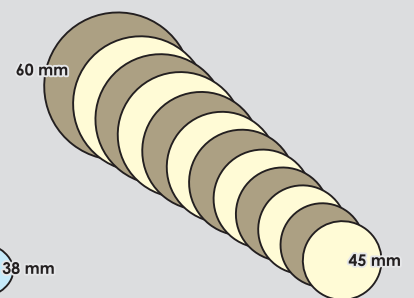

JETON SIZE

45mm to 60mm in diameter
(1.77 inch to 2.4 inch)

Inner Ring Style PREMIER DECAL CHIPS

Our latest innovation for the gaming industry is the Premier Decal Chip. It has the shape and size of a plaque, but the weight and feel of a high value chip. The ordering process is simple, just choose your base, second and third color, as you would do for your chip. Then for a more eye-catching effect, you can select from our many decal glitter options. We also offer a wide range of security features. Please contact your local sales representative for more information.



68 mm x 48 mm 3 colour ==

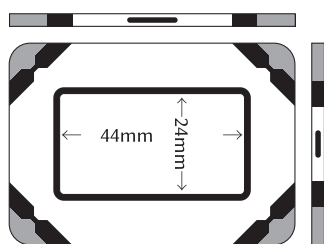

CC.870-A 68 x 48

82 mm x 57 mm 3 colour ==

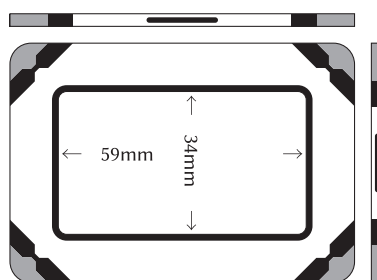

CC.870-B 82 x 57

95 mm x 66 mm 3 colour ==

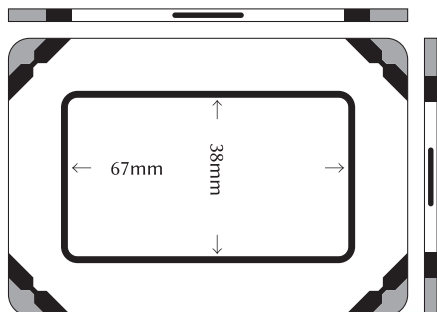

CC.870-C 95 x 66

CHIP COLOUR COMBINATION



*Inner Ring to be same colour as 2nd colour

INNER RING DESIGNS

25	50	100	500
1000	5000	10 000	20 000
25 000	50 000	100 000	500 000
N.N	\$500	\$1000	\$5000

CC.870-B, CC.870-C ONLY

1000 000	NON NEGOTIABLE
JUNKET CHIPS	
TOURNAMENT ONLY	NO CASH VALUE
Set Inner Ring	

INNER RING CAN BE CUSTOMIZED

*The ability to customize chips with your casino name is available.

*The inner ring colour is always the same as the second colour of your chip.



Inner Ring Style PREMIER DECAL CHIPS OVAL



68 mm x 48 mm 4 colour ==

82 mm x 57 mm 4 colour ==

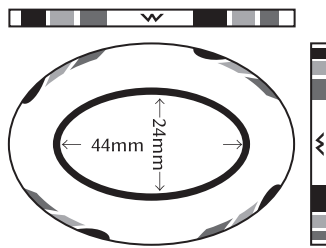

CC.880-A 68 x 48

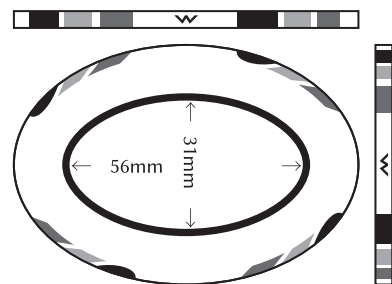

CC.880-B 82 x 57

95 mm x 66 mm 4 colour ==

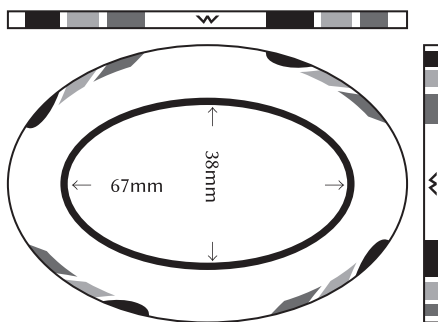

CC.880-C 95 x 66

CHIP COLOUR COMBINATION

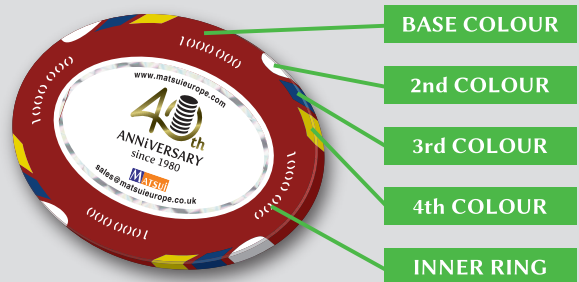

*Inner Ring to be same colour as 2nd colour

INNER RING DESIGN

1000	5000	10000
50000	100000	200000
500000	1000000	

CC.880-B, CC.880-C ONLY

NON NEGOTIABLE

INNER RING CAN BE CUSTOMIZED

*The ability to customize chips with your casino name is available.

*The inner ring colour is always the same as the second colour of your chip.

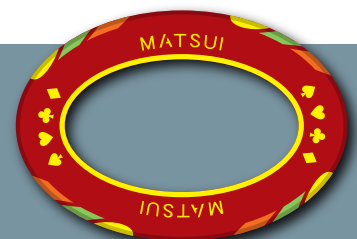

ADDITIONAL Designs

With the growing demand for a variety of decal features, we have applied our production and gaming knowledge to give you an attractive range of design options.



Glitter

Glitter decals can make a basic design look more attractive. Glitter rings, logos, letters or denominations are an effective way to make chips more eye catching. Numerous glitter design types are available, but only one type per chip design can be used.

Glitter type

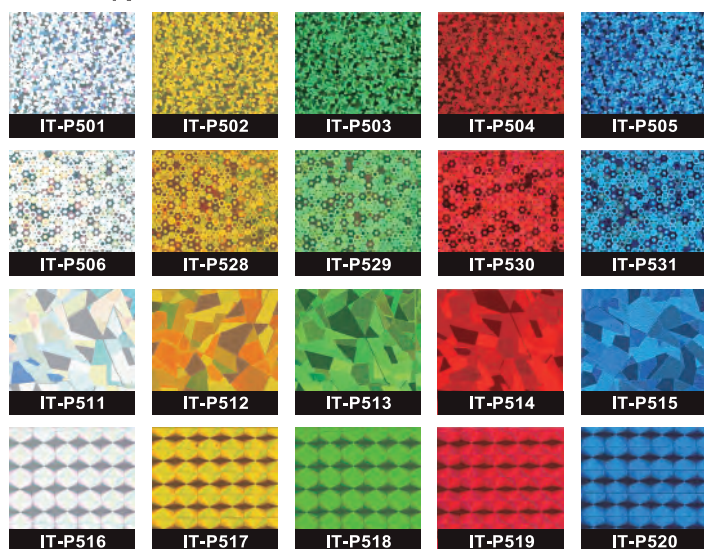

Glitter Ring type 1



Glitter Ring type 2



Glitter Logo



Glitter Base



Mirror Gold



Mirror Silver

Mirror Silver or Gold

Mirror Silver or Gold can give a similar appearance to our (Silver or Gold) coin chips. This effect is created using our unique ink range.

Serial Numbers

We can add serial numbers onto the rim of the chips, decal, coin inlay as well as our gold and silver chips.



Serial Numbers



Serial Numbers



Serial Numbers



Serial Numbers

Hologram

Why not try our new hologram decal to make a more eye-catching design?

The hologram design is common on many bank notes and passports, due to the difficulty in trying to replicate hologram properties. If holograms are good enough for bank notes, then why not have them on your cash chips!

SECURITY Feature

To protect your gaming currency, Matsui offers many different security options for your gaming chips. From standard UV Marking, original MG Eye to state of the art RFID technology, the security features are available in several different grade and complexity. These security make Matsui Chips one of the safest choice for casino operators for their gaming currency.



UV Marking

◆ Invisible UV Marking

Green or red ultraviolet markings can be added to both chips and plaques to prove their verification. The markings that can also be customized are only visible under a UV light.

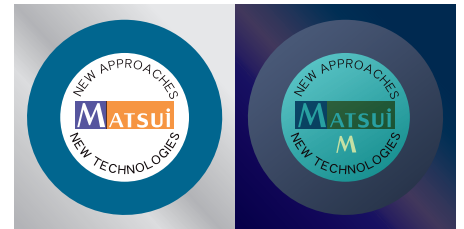

Invisible UV Marking

◆ Visible UV Marking

Silver or gold printwork of the decal can be UV reflected. The printed colours will glow green or red under a UV light.



Visible UV Marking

SECURE-EM-CHIP / Anti-Theft

The actual loss of gaming chips through internal theft is difficult for anyone to measure. With the MATSUI Secure-EM-Chip you can feel safe in the knowledge that no chips will be removed from the gaming floor without detection.

◆ Contentment for Managers and Security

Casino management can have peace of mind knowing that gaming chips will not be taken off the gaming floor by casino without their specific authorization.

◆ Alarm Activated

When the chips pass through strategically placed security sensors, the alarm is activated. These chips can also be detected by hand held security devices.

• HOW IT WORKS

Electronic Magnetic (EM) material is applied to the inside of the gaming chip. This then generates an invisible electro magnetic field that can trigger an alarm when it passes through electronic detection gates. Most casinos have a route that staff members must follow off the gaming floor. By using MATSUI's superb EM Chip with EM Gate, you can ensure superb detection and stop all casinos gaming chip theft.



Amorphous Magnetic EM Chip

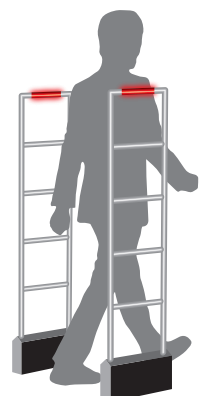

EM Gate

Laser Trace

This is the best solution for a quick check of your chips. By adding our security material to the base colour of your chip, the unique laser pen will show if the chip is genuine. This is ideal for checking chips in the float tray.

We achieve this by mixing special reactants with the raw materials without affecting the colour of the chips. They will appear the same as the normal chips.

The colour of the laser depends on the base colour. This is mainly expressed in green, however it can also be expressed in red depending on the base colour chosen.

The Laser trace is also available on the chip decal. This is applied to all of the printed surface.



Detecting the chip's face (Green color)



Detecting the chip's face (Red color)

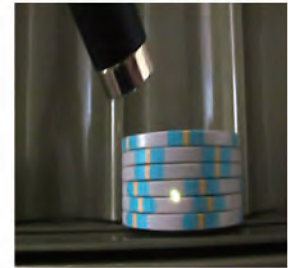

Detecting the chips in a stack or float tray



Laser option on the decal

• HOW IT WORKS

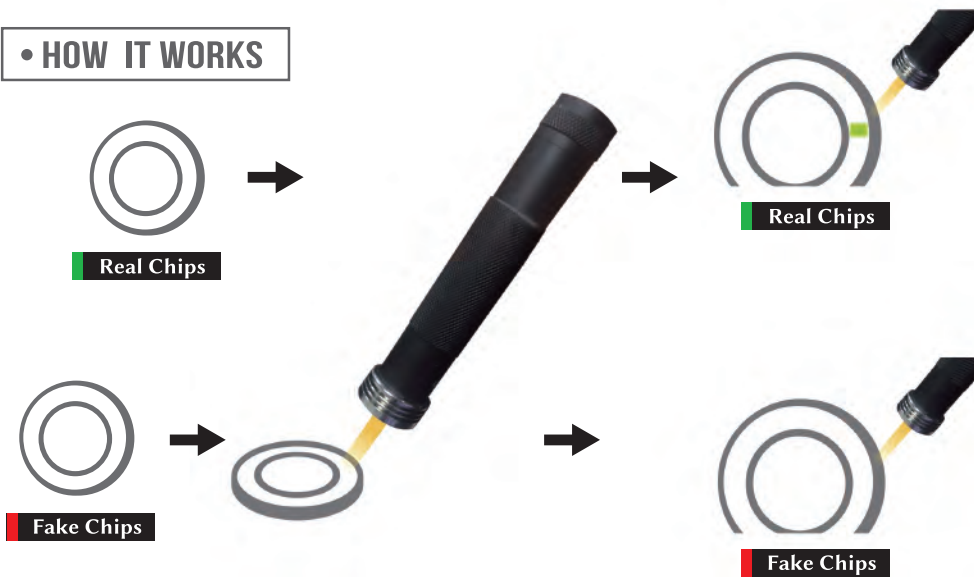

Mould UV

The UV security feature can be applied to the mould so that it can be identified through a special detector.

Maintain the unique point color of the chips. Quick verification available in large quantities as features are applied to the point color part.

The UV security feature should be applied to the 2nd or 3rd colour of the chip.

* There is a difference in the degree of emission by the color of the injected raw materials.



Detector



Before lighting



After lighting

MG EYE SECURITY PRINTING

A unique decal printing method, exclusive to MATSUI, lets us create a gaming chip impossible to duplicate.

◆ MG EYE Scanner

When chips are projected by lens, a print with special ink will be shown on LCD screen. The production time is unchanged from that of non MG Eye chips, so all Matsui chips are delivered at exceptional lead time. This device is available to use with AC adaptor or battery. If you connect RCA cable to the output terminal, the vision of LCD screen will be able to project to external monitor.

◆ Specifications

MG EYE Scanner	
Dimension	63 (W) x 162 (L) x 70(H) mm
Weight (without battery)	190g
Power Consumption	DC5V / 620mA

AC Adaptor	
Voltage	Input AC100-240V Output DC5V/2A
Frequency	50/60Hz

• HOW IT WORKS



MG EYE - EDGE

Available in all decal chips including Premier Decal Chips, security taggant specially developed for Matsui Chips can be added to base colour to your chips. The portable reader can check if the chip is genuine or counterfeit.

◆ Specifications

MG EYE EDGE Reader	
Dimension	59 (W) x 36 (L) x 14 (H) mm
Weight	23g
Power	Battery operated

• HOW IT WORKS

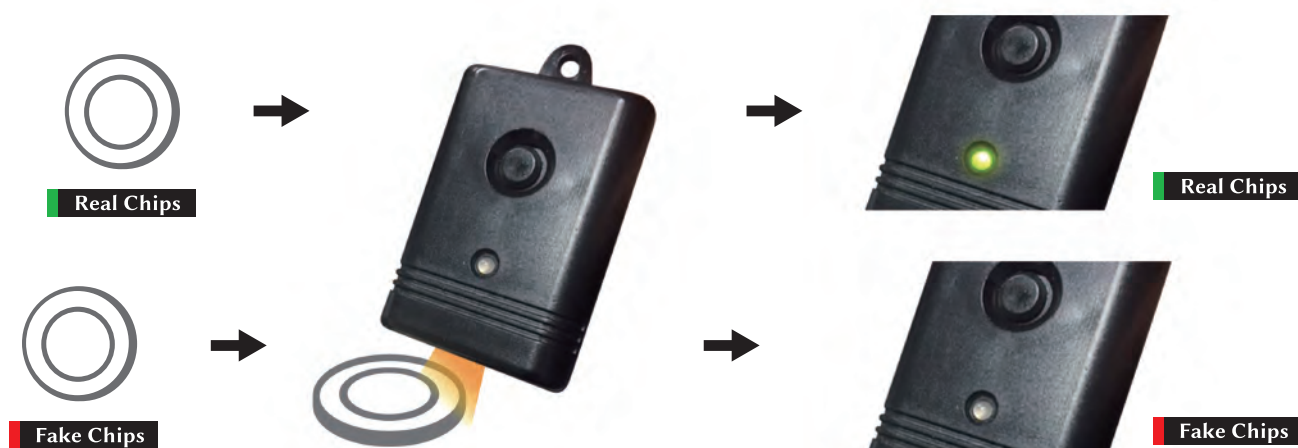

RFID

Matsui 13.56 RFID Chips & System is the latest security system using radio frequency identification at 13.56Mhz. It's now possible to recognize a large volume of chips simultaneously under stable cash desk conditions. This will surely become an innovative new approach to your casino management. With these chips designed at 11g (weight) we then apply an electronic magnetic label to prevent robbery. This is based on the existing security environment. All the standard Matsui decal chips, plaques and jetons are now available with RFID.

It can protect your casino from counterfeit chips, whilst helping acquire information and confirmation about chip trading, stock situations and actual account of each table all in real time.



Features

◆ HF RFID

- Capable of recognizing many units quickly and at the same time.
- Stable packaging structure and format safe from breakage.

◆ Grid Computing

- Even when the chip is forged physically, the logic mechanism can perfectly control the chips.
- Perfectly prevents information loss when there is hardware or network system trouble.

◆ Overcame RF Interference

- Provides the hardware system with the algorithm which minimized the RF interface
- Provides the method to control RF interference through software mechanism.

◆ Flexible Software System

- Modules suitable for each system are provided that they can be easily operated with the existing casino management system (CMS)
- The system is designed independently from RFID hardware.

Expected Effects

- Prevention of forgery of casino chips
- Prevention of theft of casino chips
- Monitors various rule breaking activities in the casino
- Checks the stock of casino chips

- Real time monitoring casino trade status
- Real time settlement by each table
- Real time confirmation of betting, winning, and losing status for each customer



SECURITY

Manufacturing



The MATSUI complex on the outskirts of Seoul, Korea houses our purpose built chip manufacturing plant and modern offices. The manufacturing units and the dedicated staff are committed to increasing customer satisfaction through distribution of the world's highest quality gaming chips. This includes the customized marketing, careful design and precise production incorporating the latest innovative security features. MATSUI uses a wide range of environmentally friendly materials. We also apply state of the art moulding techniques to manufacture the most accurately shaped and time tested gaming chips. The plant is extensively maintained, keeping a clean and temperature controlled environment, thus ensuring the quality of the chips are always kept to the highest possible standards.

The manufacturing units and the dedicated staff are committed to increasing customer satisfaction through distribution of the world's highest quality gaming chips. This includes the customized marketing, careful design and precise production incorporating the latest innovative security features.

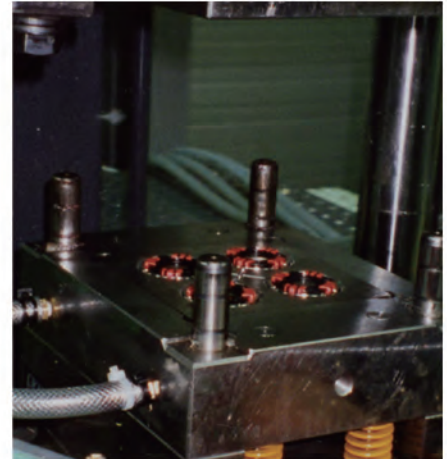

When producing gaming chips, security is one of the most vital aspects to be considered. MATSUI solves this issue using a variety of methods.

Top range security cameras cover both the manufacturing line and the outside of the complex. All chips and materials used during the manufacturing process are secured in vaults only accessible to authorised personnel and 24hr security guards are in place both inside and outside the plant.

These precautions guarantee that any product cannot be removed from the plant without authorised approval.

All gaming chips data is stored in a management controlled setting to ensure all data is secure and repeat orders can be readily accommodated.



CHIP ACCESSORIES

We can supply full range of accessories related to gaming chips. At your gaming tables and also for cage and backyard, Matsui can support you through all the aspect of your operation.



DISPLAY RACK
Tree style

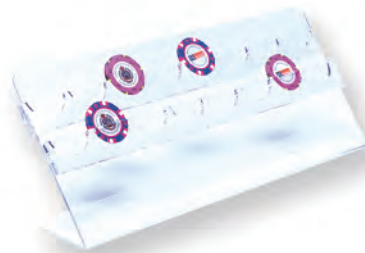

DISPLAY RACK
for value chip cover



FLOAT TRAY
12 tube / 15 tube / Single or Double



CHIP CASE
accomodate 100pcs of 39-43mm chip,
Stackable

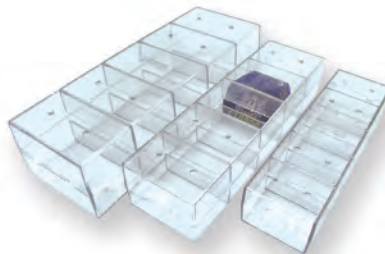

PLAQUE CASE
Large (for 108x75mm)
Medium (for 82x57mm)
Small (for 68x48mm)



ROULETTE VALUE CHIP COVER
with 2 locks



CHIP CARRYING CASE
accommodates 8 x 100 chip trays
accommodates 10 x 100 chip trays



UV LIGHT
w/cable or w/o cable



HANDY LED UV LIGHT
Rechargeable

TABLE LAYOUT

SYNTHETIC LAYOUTS

Developed with the latest technology, our new Eternity Synthetic Layouts are extremely durable and long lasting. Printed with silk screens or by heat transfer, these highly durable and clear colour contrasts layouts will stand the test of time. Choose from over 25 standard base colours or customize your own design to create a unique, high quality layout specific to your requirements. Available in special table games. Pai gow, Three card poker, Bonus black jack, etc.



WOOL LAYOUTS

Very rich traditional material with high contrast silk screen printing. Proven in the work place, Matsui's luxury wool layouts possess stain, burn and fade resistant features that significantly lower the amount of layout changes in the world's largest casinos.



ROULETTE (size: mm)

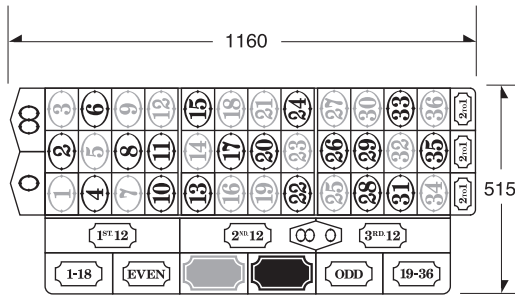

WL.020 2600 x 1600

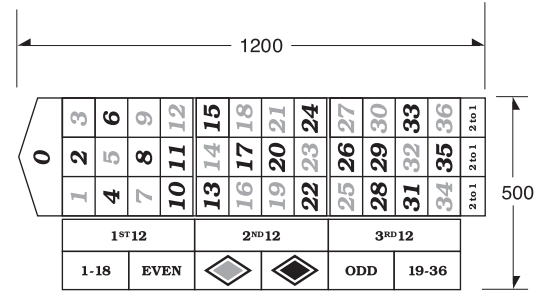

WL.026 2900 x 1600

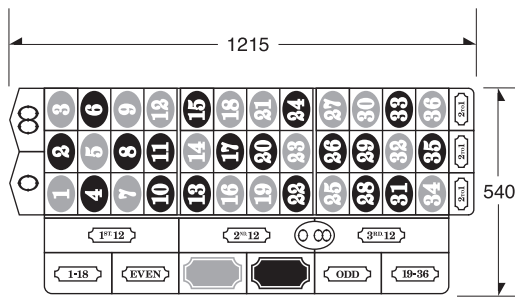

WL.0202 2900 x 1600

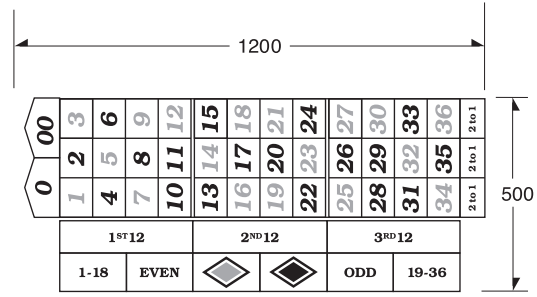

WL.027 2900 x 1600

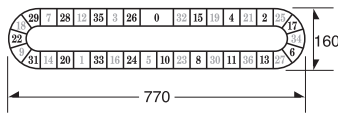

RT-1

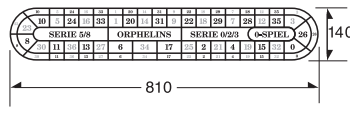

RT-2

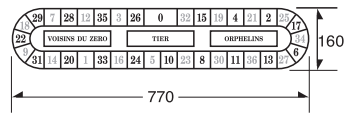

RT-3

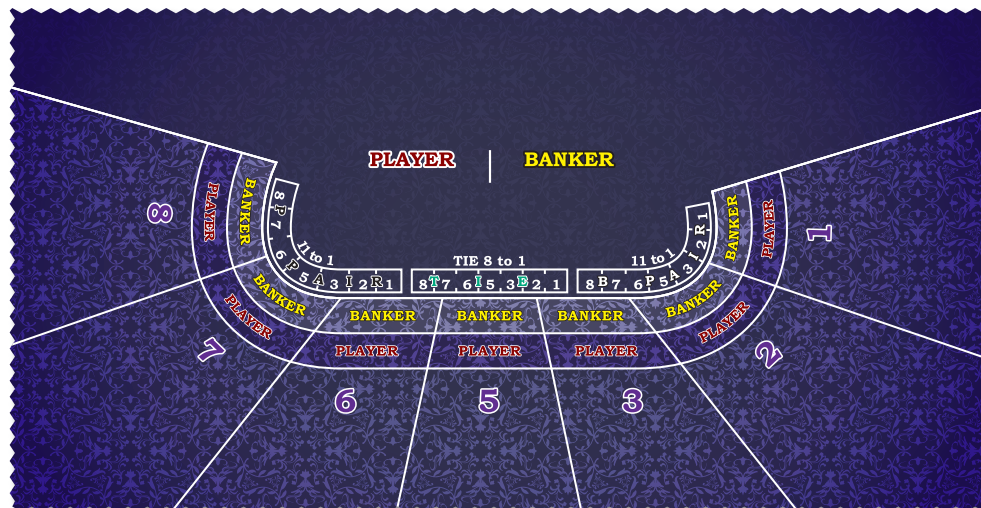

**Graphic printing available for synthetic layout.
Please contact your Matsui sales for more details.**

BACCARAT (size: mm)

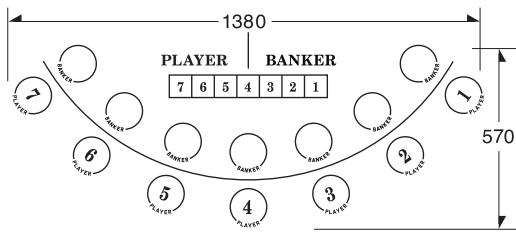

WL.0606 2300 x 1200

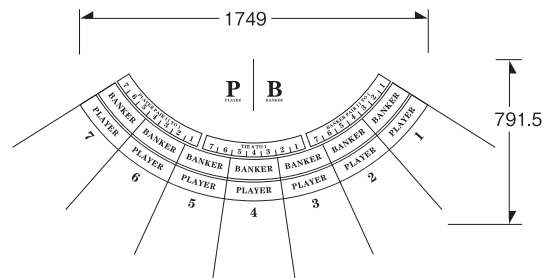

WL.0648 2600 x 1600

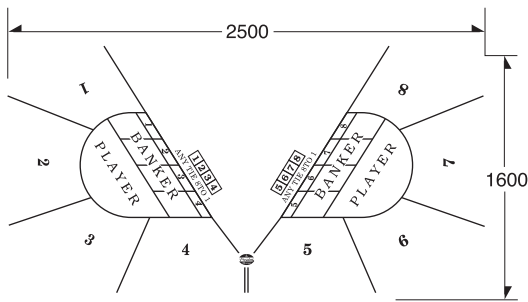

WL.080 2600 x 1600

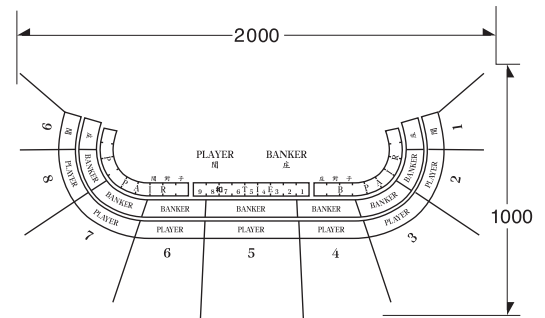

WL.0630 B 2600 x 1600

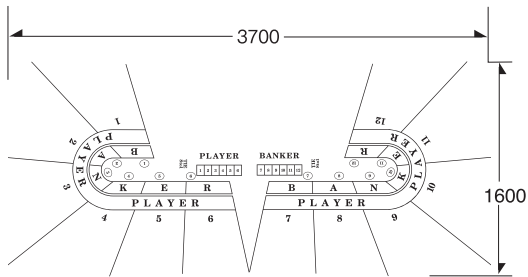

WL.1202 3700 x 1600

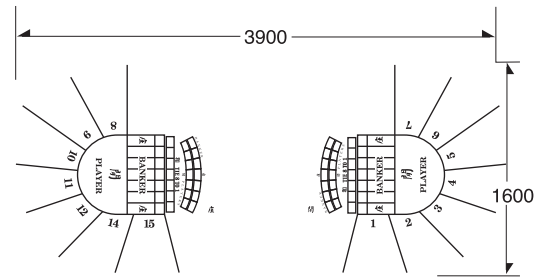

WL.1404 C 4000 x 1600

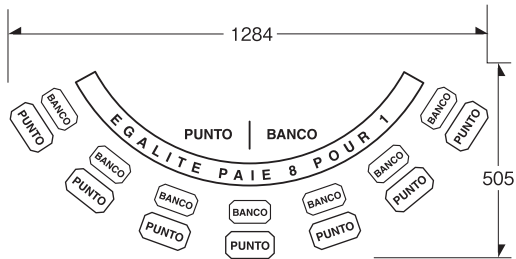

ML.00789-16K 2300 x 1600

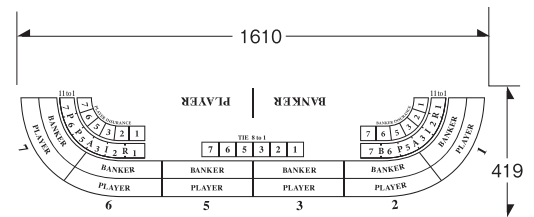

ML.00316-14K 2300 x 1600

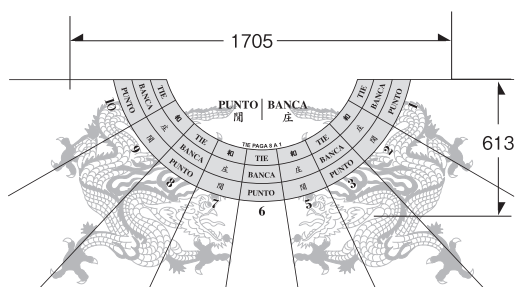

ML.00644-13K 2300 x 1500

BLACK JACK (size: mm)

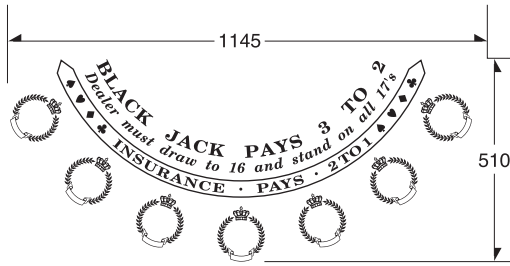

WL.010 2300 x 1200

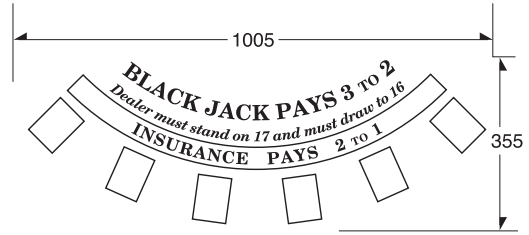

WL.011 2300 x 1200

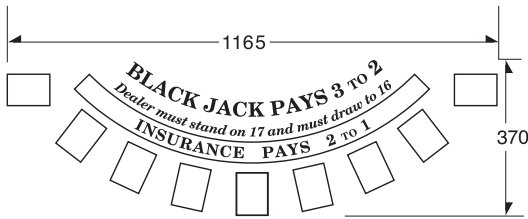

WL.013 2300 x 1200

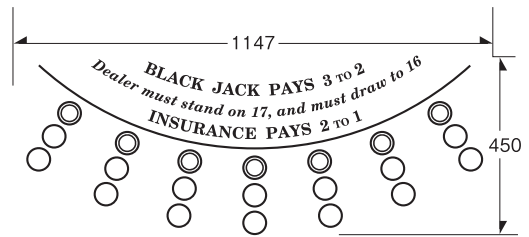

WL.014 2300 x 1200

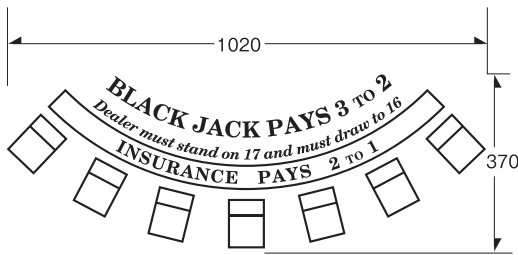

WL.0111 2300 x 1200

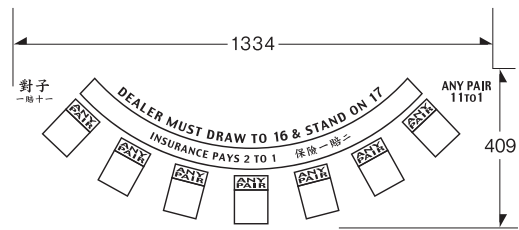

ML.00023-10J 2300 x 1200



Graphic printing available for synthetic layout.
Please contact your Matsui sales for more details.

POKER (size: mm)

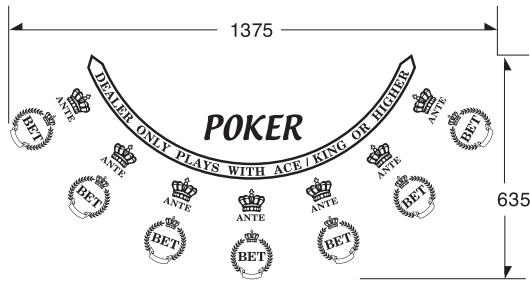

WL.0403 2300 x 1600

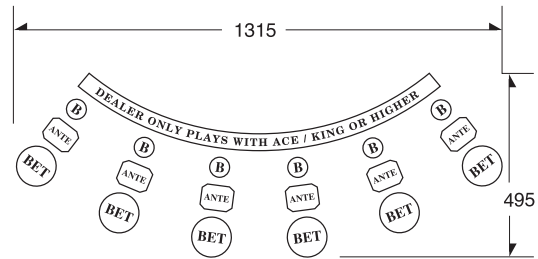

WL.2001 2300 x 1200

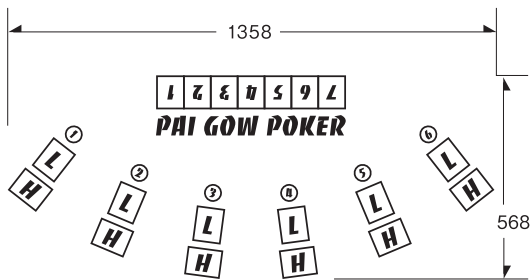

WL.0619 2300 x 1600

TEXAS HOLD'EM (size: mm)

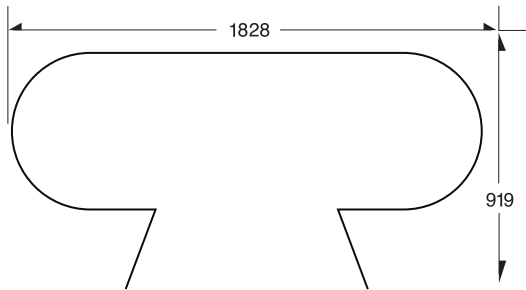

WL.2004 2600 x 1200

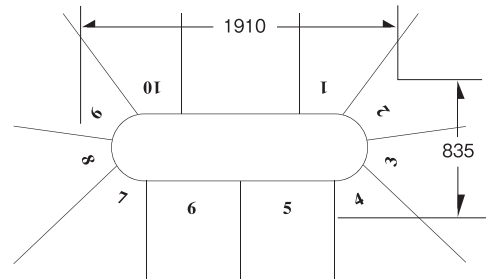

WL.2018 2700 x 1600

CRAPS (size: mm)

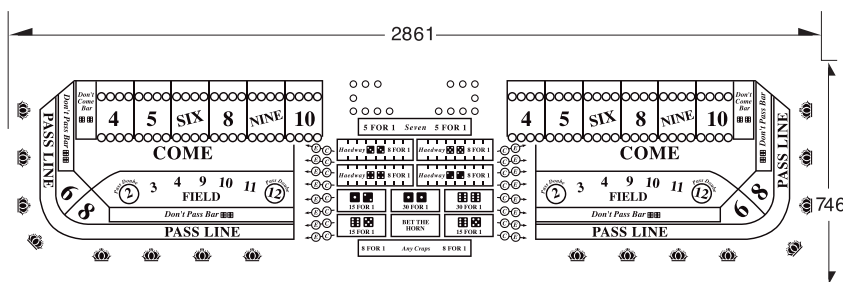











WL.2020 3600 x 1600





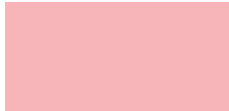





Synthetic Layout Colour Chart

				
MW070501	MW070502	MW070503	MW070504	MW070505
				
MW070506	MW070507	MW070508	MW070509	MW070510
				
MW070511	MW070512	MW070513	MW070514	MW070515
				
MW070516	MW070517	MW070518	MW070519	MW070520
				
MW070521	MW070522	MW070523	MW070524	D-MUSTARD
				
BROWN	D-SAND	TAN		

Wool Layout Colour Chart

				
Green	Light Blue	Lavender	Burgundy	Cedar Green
				
Royal Blue	Grey	Black	Pink	Beige

Wool Layout Print Colour Chart

										
Light Blue	Blue	Purple	Red	Pink	Orange	Yellow	Green	White	Grey	Black

THE REVOLUTION Wheel

Elegant in design and finished with the world's finest veneers. Designed and manufactured in Japan, the MATSUI RevolutionWheel is a pre-requisite for any casino. Proven in tests, the new bearing assembly guarantees a spin rate, which is unsurpassed in its smoothness and duration. Equipped with a non-ferrous separator ring which can be indexed to 37 or 38 positions, the MATSUI Revolution Wheel is fully tamper proof for guaranteed security.

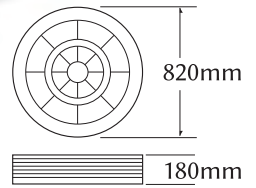

The colours and design can be customized to suit your operation.



- ① Turret machined and polished from solid metal and can be engraved with the casino name and logo.
- ② Adjustment bolt
- ③ Japanese designed and precision-engineered bearing assembly ensures a superior spin rate.
- ④ Cone finished with the finest veneers.
- ⑤ Non-ferrous CNC machined separator ring, capable of being indexed to 37/38 positions.
- ⑥ Rotor assembly machined to 0.1mm tolerances.
- ⑦ Ball track made from versatile heat resistant Bakelite, preventing wheel bias from premature wearing.



The Revolution is available with single or double zero. Font and colours can be customized.

CARD SHREDDER

Will shred all known paper/plastic playing cards.
Bent cards are not a problem!

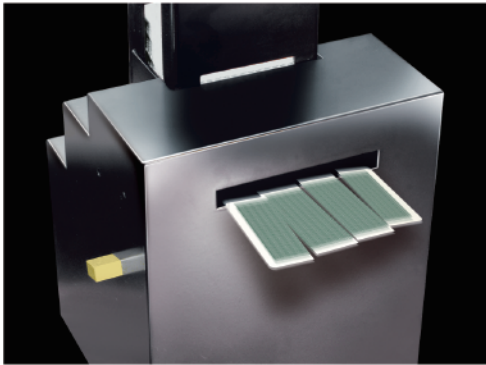

MA-5 for PLASTIC & PAPER playing cards

Designed for back room use, the powerful MA-5 can shred over 20 decks per minute and the MA-6 can easily shred over 30 decks per minute ensuring all used cards are thoroughly disposed of while saving valuable hours in the process.

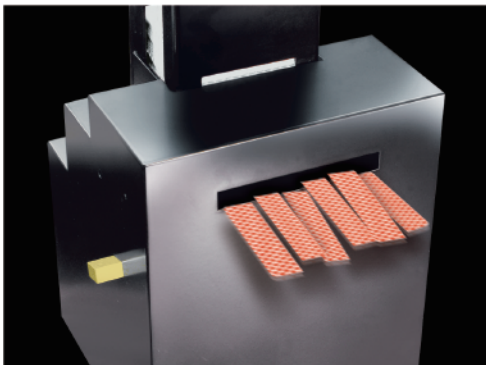

MA-6 for PAPER playing cards

Specifications

Dimension	W195 x D185 x H655mm
Gross Weight · Material	13.7kg · ABS Resin and Steel
AC Main Lead	2800mm Length
Cutting Speed	20 Decks per minute
CUT	4(MA-5)/6(MA-6)pcs
Power Consumption	90W
Voltage	100-125V or 200-230V
Frequency	50/60Hz
Colour	Black
Accessories	Spring, AC cord, Allen Wrench x 2



ACCESSORIES

Matsui Gaming can also provide a wide range of casino accessories. We are happy to support you in all your requirements. Please contact your nearest sales office for more details.



Roulette Ball



Roulette Win Marker



Baccarat Marker



Lammer



Matsui Premium Playing Cards
Matsui Standard Playing Cards



Craps Dice



LCD Table Limit Sign



Solid Dealing Shoes

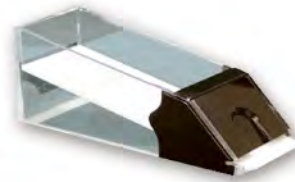

Clear with Colored Trim
Dealing Shoes-1

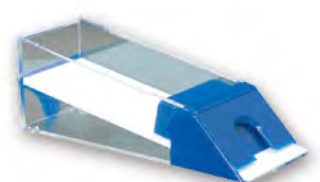

Clear with Colored Trim
Dealing Shoes-2



Digital Limit Signs



DS080 Dealing Shoe
(For 8 Deck, Frosted)



DS050 Dealing Shoe
(For 8 Deck, White)



DS030 Dealing Shoe
(For 8 Deck, Black)

CASINO THEMED Ashtrays

Our casino themed ashtrays are a perfect customer/prize give away, these porcelain hand painted ashtrays can also be customised and painted in your preferred colour with casino logo providing constant advertising for your casino.



AT.020 Roulette Wheel -Big Size-
φ 200mm×H45mm / φ 8inch×1.77inch



AT.040 Roulette -Big Size-
W240mm×D130mm×H40mm / W9.6inch×D5.1inch×H1.57inch



AT.220 Roulette Wheel -Medium Size-
(Black)

AT.221 Roulette Wheel -Medium Size-
(White)
φ 130mm×H30mm / φ 5.2inch×1.18inch



AT.120 Roulette Wheel -Mini Size-
φ 110mm×H25mm / φ 4.4inch×H0.98inch



AT.121 Roulette Wheel -X.Small Size-
φ 95mm×H20mm / φ 3.8inch×H0.78inch



AT.350 Gaming Chip
φ 81mm×H63mm / φ 3.24inch×H2.48inch



AT.030 Baccarat -Big Size-
W240mm×D125mm×H33mm
/ W9.6inch×D4.92inch×H0.10inch



AT.130 Baccarat -Mini Size-
W140mm×D75mm×H25mm
/ W5.6inch×D2.95inch×H0.98inch

CAN BE CUSTOMIZED

Colours and logos can be tailored to suit your needs.

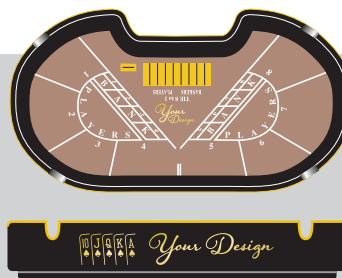



AT.010 Black Jack -Big Size-
W240mm×D125mm×H30mm
/ W9.6inch×D4.92inch×H1.18inch



AT.210 Black Jack -Medium Size-
(Black)

AT.211 Black Jack -Medium Size-
(White)
W 165mm×D85mm×H28mm
/ W6.6inch×D3.34inch×H0.99inch



AT.110 Black Jack -Mini Size-
W 140mm×D75mm×H25mm
/ W5.6inch×D2.95inch×H0.98inch



AT.111 Black Jack -X.Small Size-
W128mm×D65mm×H22mm
/ W5.12inch×D2.55inch×H0.86inch



AT.310 Craps



Ashtray
W162mm×D85mm×H35mm
/ W6.48inch×D3.34inch×H1.37inch

Wooden Frame
W124mm×D60mm×H26mm
/ W4.92inch×D2.36inch×H1.02inch



AT.320 Sic Bo
W142mm×D90mm×H30mm
/ W5.68inch×D3.54inch×H1.18inch



AT.340 Star
W150mm×D120mm×H30mm
/ W6inch×D4.72inch×H1.18inch



AT.330 Crown
W123mm×D105mm×H30mm
/ W4.92inch×D4.13inch×H1.18inch





**Design Your Own Chips
on our WEB site**

With our interactive and easy to use chip design tool, you can now choose your own moulds and colours to create chips that will be unique to your casino.

www.matsui-gaming.co.jp



Matsui Gaming Machine co.,LTD.

(TOKYO, JAPAN)

TEL : 81-3-5467-5211 FAX : 81-3-5467-5218

M·G·M WORLD co.,LTD.

(SHIHWA, KOREA)

TEL : 82-31-431-8611 FAX : 82-31-431-8638

MATSUI ASIA LTD.

(MACAU S.A.R, CHINA)

TEL : 853-2875-2830 FAX : 853-2875-2831

MATSUI AMERICA INC.

(LAS VEGAS, U.S.A)

TEL : 1-702-220-4911 FAX : 1-702-589-5858

MATSUI EUROPE LTD.

(MANCHESTER, U.K.)

TEL : 44-(0)161-736-9011 FAX : 44-(0)161-736-9002